

EVOLine® Catalogue 2019



Systems



9
One



17
Circle80



21
Square80



27
BackFlip



31
Port *Push*



37
Port



45
FlipTop *Push*



51
FrameDock



55
Dock Square



59
Dock



65
R-Dock



69
T-Dock



73
V-Dock



77
V-Port



81
U-Dock



85
Up



91
Vertical

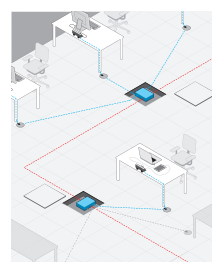

95
Decentralised
Electrical
Distribution

Modules



99
Modules



102
Sockets



111
Power Supply
Modules



114
Data
Modules



116
Multimedia
Modules

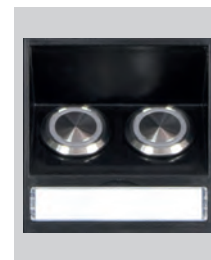

124
Switches &
Pushbuttons



126
Protection
Modules



128
Interchangeable
Modules



141
Kinetics

Add-On



145
Plug



149
Qi Charger



153
Express



167
Cable
Management



173
Accessories



177
Sales support

EVoline[®] Modular System

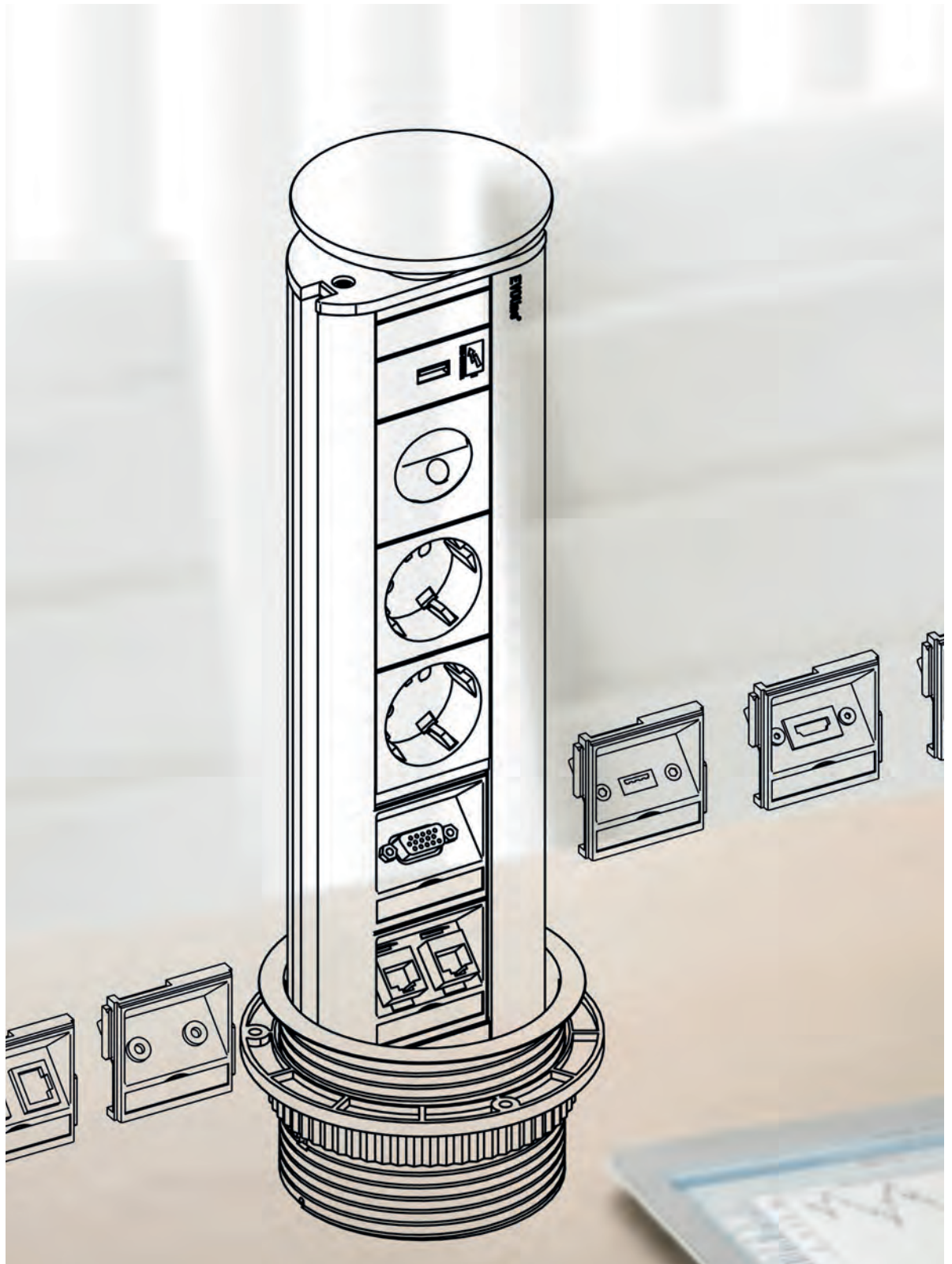

Example of order

How to configure your individual EVOLine product

1. Choose your EVOLine product

- Port → 43
- Port Push → 36
- Dock Square → 58
- FlipTop Push → 49
- FrameDock → 54

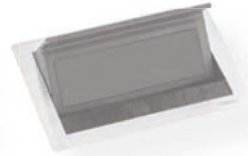

2. Make your choice of modules

- Sockets → 102
- Data-Modules → 114
- Multimedia-Modules → 116
- Interchangeable Modules → 132
- Switches → 124

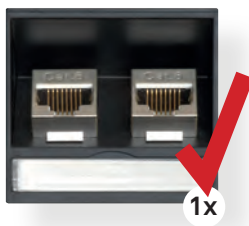

Dock
→ 64



R-Dock
→ 68



U-Dock
→ 84



V-Dock
→ 76



Vertical
→ 94



3. Your configuration

Protection-Modules
→ 126



Kinetics-Modules
→ 143



Power Supply-Modules
→ 111



EVOLine[®] One

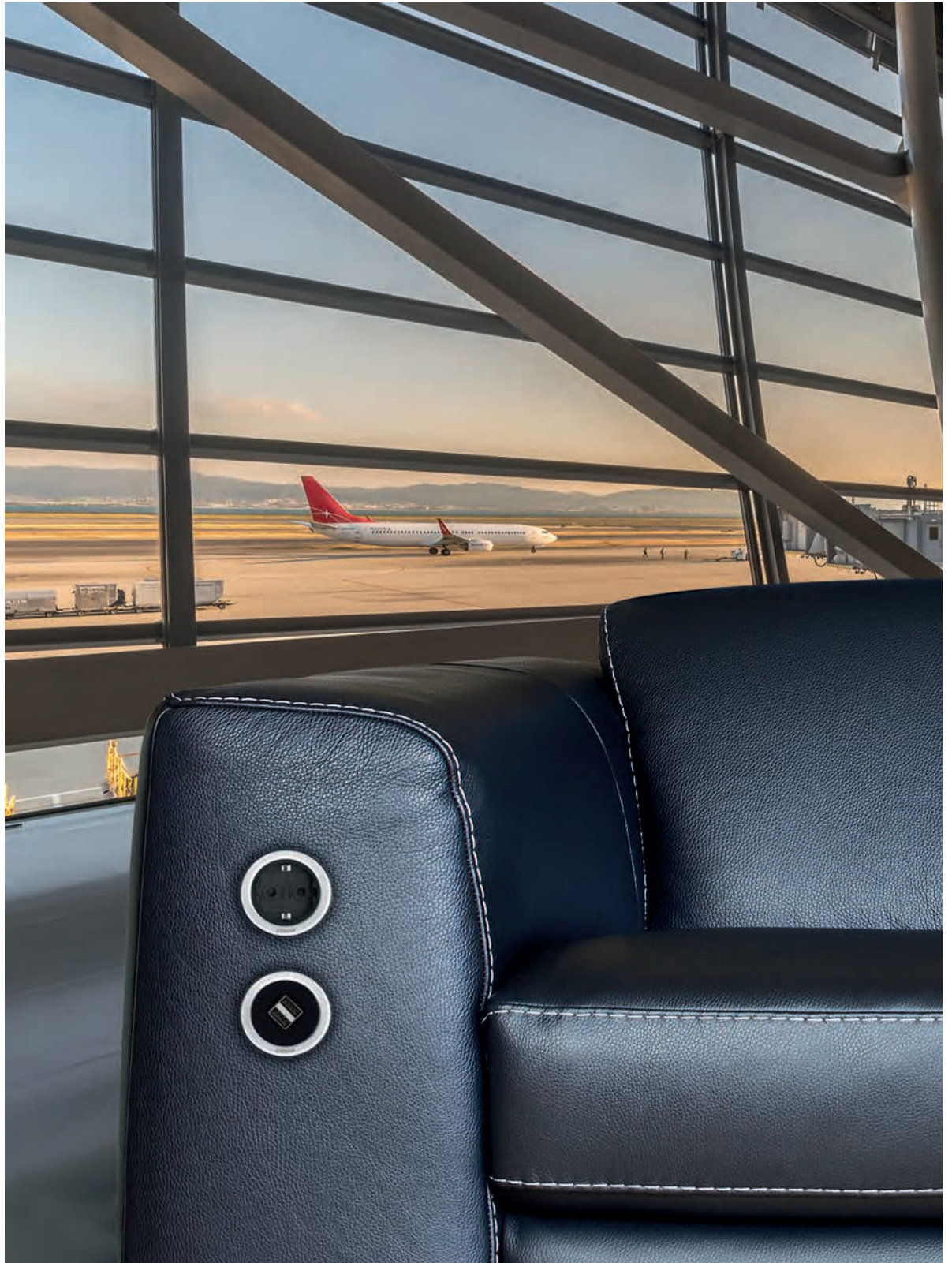

EVoline[®] One

The new One electrification system from EVoline is a compact power or data access system that can be easily integrated into any design concept. Whether at the workplace, in the conference room, in the lounge area or in the kitchenette, the EVoline One ensures fast and secure access to power or data, and that to a very space-saving and discreet way.

The round single socket can be installed horizontally or vertically and can be adapted to the respective requirements thanks to the wide range of module inserts. In addition to the variable inserts, EVoline also offers the individually selectable rotary cover.

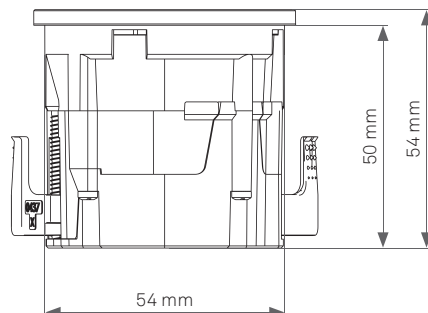
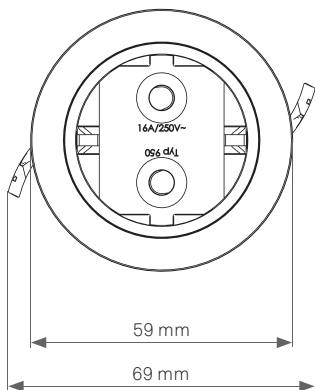

Case	Plastic
Ornament ring,	- Plastic, solid
Rotating lid	- Stainless Steel inserts
Installation type	Flush mounted
Plate thickness	6 - ∞ mm

Internationally approved
socket modules or data and
multimedia modules

Cover rings in various colours
and materials, optionally with
or without swivel lid.



Clamp fixed under the plate or in a
hole of any depth.
Patent pending.

Borehole
Ø 54 mm
2 1/8 inch

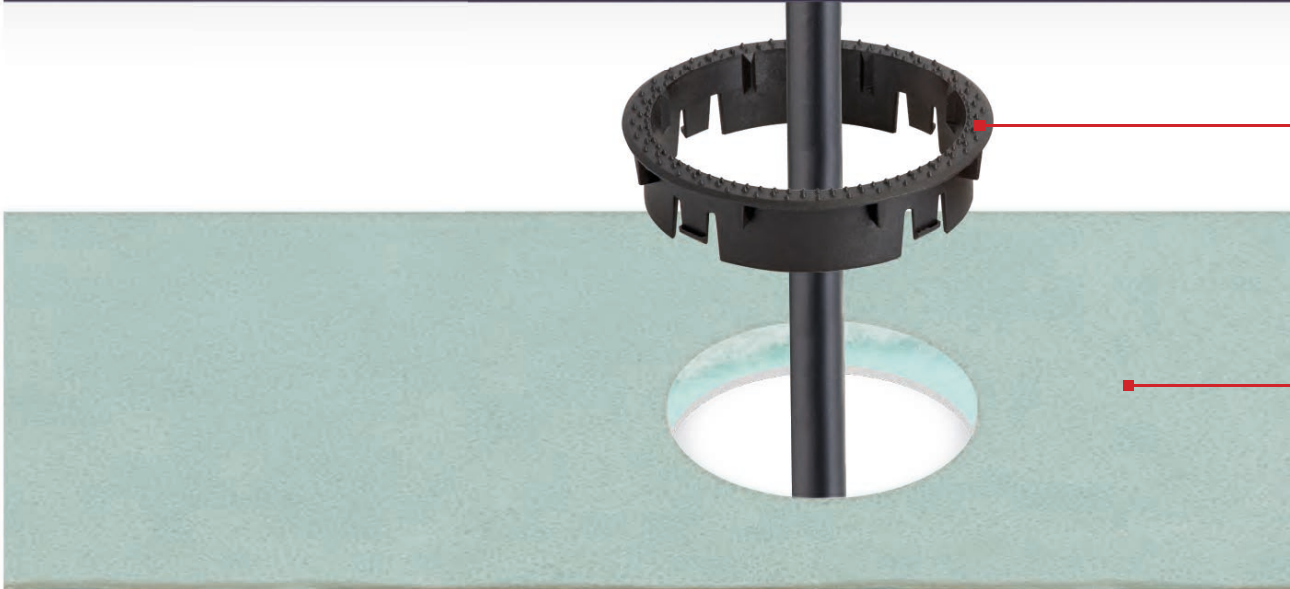
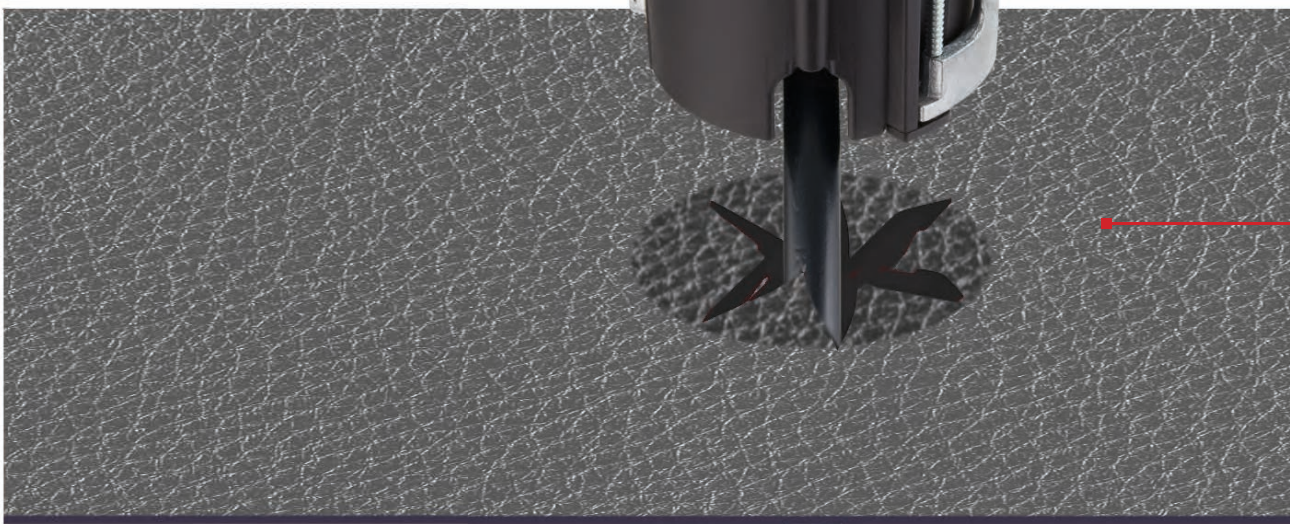

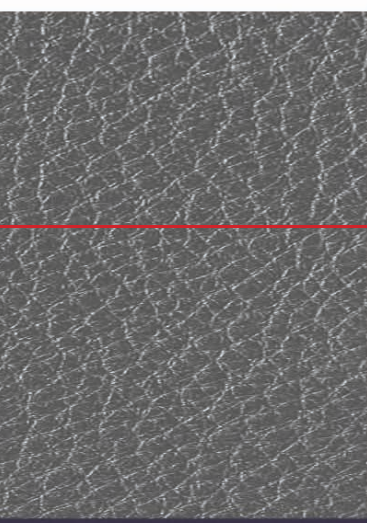

Fabric or leather cover

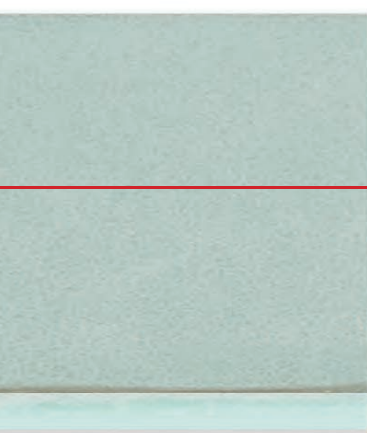

Upholstery sleeve

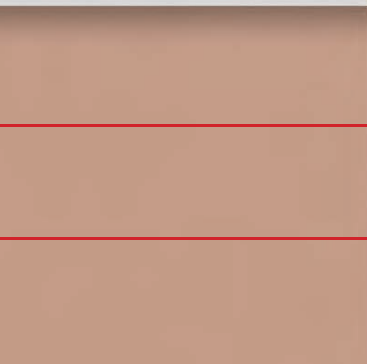







Furniture upholstery

Bore \varnothing 60 mm / 2 ³/₈ inch

Furniture basic construction

Description	Picture	Specifications	Order Number
<p>EVOLine One with VDE-socket</p> <p>Housing made of plastic Clamping wing made of metal</p>		<p>Housing color: black Ring color: black</p>	1592 8000 0900
<p>VDE-socket, 16 A with contact-protection fixed power cable 3 m with protective contact angle plug.</p>		<p>Housing color: black Ring color: black with stainless steel inlay</p>	1592 8000 1100
		<p>Housing color: white Ring color: white</p>	1592 8000 4300
		<p>Housing color: white Ring color: white with stainless steel inlay</p>	1592 8000 6100
<p>EVOLine One with VDE-socket and lid</p> <p>Housing and lid made of plastic Clamping wing made of metal</p>		<p>Housing color: black Lid color: black</p>	1592 8000 4100
<p>VDE-socket, 16 A with contact-protection fixed power cable 3 m with protective contact angle plug.</p>		<p>Housing color: black Lid color: black with stainless steel inlay</p>	1592 8000 3900
		<p>Housing color: white Lid color: white</p>	1592 8000 4200
		<p>Housing color: white Lid color: white with stainless steel inlay</p>	1592 8000 6200

Description	Picture	Specifications	Order Number
<p>EVoline One with double USB Charger</p> <p>Housing made of plastic Clamping wing made of metal</p>		<p>Housing color: black Ring color: black</p>	1592 8000 1200
<p>Double USB Charger Type A, 5 V / 2,1 A max. fixed power cable 3 m with protective contact angle plug.</p>		<p>Housing color: black Ring color: black with stainless steel inlay</p>	1592 8000 1400
		<p>Housing color: white Ring color: white</p>	1592 8000 1300
		<p>Housing color: white Ring color: white with stainless steel inlay</p>	1592 8000 6300
<p>EVoline One with double USB Charger and lid</p>		<p>Housing color: black Lid color: black</p>	1592 8000 4400
<p>Housing and lid made of plastic Clamping wing made of metal</p> <p>Double USB Charger Type A, 5 V / 2,1 A max. fixed power cable 3 m with protective contact angle plug.</p>		<p>Housing color: black Lid color: black with stainless steel inlay</p>	1592 8000 4000
		<p>Housing color: white Lid color: white</p>	1592 8000 4500
		<p>Housing color: white Lid color: white with stainless steel inlay</p>	1592 8000 6400

Description	Picture	Specifications	Order Number
<p>Configurable Basic Housing EVoline One</p> <p>Housing made of plastic Clamping wing made of metal</p> <p>Please state the following in your purchase order: Clamping wing: for mounting surface thickness of 9mm to 25mm Clamping wing, short: for mounting surface thickness of 21mm to 38mm</p>		<p>Housing</p> <p>black, for electricity</p> <p>black, for data</p> <p>white, for electricity</p> <p>white, for data</p>	<p>9332 3280 0000</p> <p>9332 3590 0000</p> <p>9332 3290 0000</p> <p>9332 3600 0000</p>
<p>EVoline One ring</p>		<p>black / white with stainless steel insert</p> <p>Please indicate the colour when ordering</p>	<p>9332 3520 0000</p>
<p>EVoline One ring</p>		<p>black / white</p> <p>Please indicate the colour when ordering</p>	<p>9332 3510 0000</p>
<p>EVoline One ring with lid</p>		<p>black / white with stainless steel insert</p> <p>Please indicate the colour when ordering</p>	<p>9332 3560 0000</p>
<p>EVoline One ring with lid</p>		<p>black / white</p> <p>Please indicate the colour when ordering</p>	<p>9332 3550 0000</p>
<p>EVoline upholstery sleeve</p> <p>Additional fixing sleeve for installation in an upholstered piece of furniture</p>		<p>Flat upholstery sleeve (Upholstery thickness of up to 5,5 mm max.)</p> <p>High upholstery sleeve (Upholstery thickness of up to 11 mm max.)</p>	<p>9332 3490 0000</p> <p>9332 3500 0000</p>

EVoline® Circle80



The three-in-one solution for modern workplaces.

EVoline® Circle80

The EVoline Circle80 intelligently combines three functions into one: a power outlet, a double USB charger and a cable duct.

A combination that provides not only a safe electricity supply but also a flexible option for data cables thanks to an additional cable duct opening.

With its slim design, the EVoline Circle80 presents itself as a real eye-catcher and elegantly hides excess cables with its practical cable duct.

The flexible installation solution can be integrated into tabletops or benches in almost all office areas ranging from conference rooms to lounges.

Furthermore, the small installation depth and the EVoline cable fixing system ensure easy and quick installation.

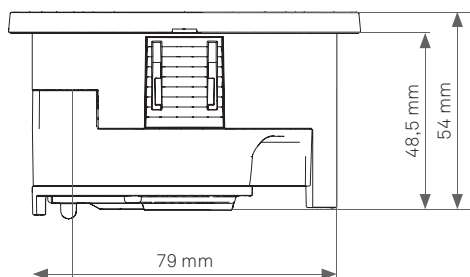
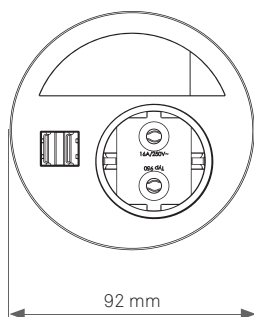

Dimensions in mm

Housing	Plastics
Installation	Flush-mounted Diameter Ø 80 mm
Surface thickness	10 – ∞ mm





Internationally certified socket modules.

Cable duct, can also be used for excess cables.

Double USB charger

80mm diameter cutout

Quick assembly for mounting surface thickness of 10mm+.

Description	Picture	Specifications	Order Number
<p>EVoline Circle80</p> <p>Type 927-3 1 x VDE-socket, 16 A, with contact-protection 1 x Double USB Charger 2,1 A fixed power cable 3 m with protective contact angle plug.</p>		black	1592 7300 0900
		white	1592 7300 1000

EVOLine[®] Square80



Innovative technology for the smallest of spaces.

EVoline[®] Square80

EVoline Square80 fits into standard openings that are pre-made with a diameter of 80 mm. It provides a power socket, a USB charger, and a data connection.

In its Qi version EVoline Square80 offers an additional wireless charging surface integrated into the cover, for charging of Qi capable mobile phones.

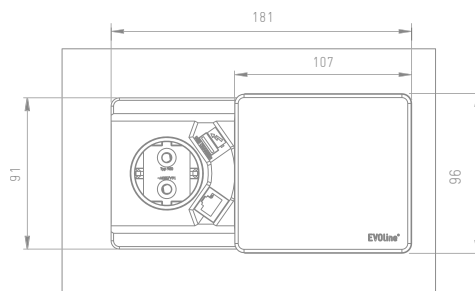
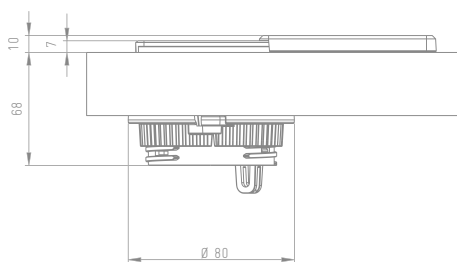

Dimensions in mm

Housing	Plastics
Cover	Plastics
Installation	Flush-mounted Diameter Ø 80 mm
Surface thickness	10 – 50 mm



Optional Qi charging surface



USB charger



International power socket modules

Various data connections

Port diameter 80 mm

Quick installation,
for surface thickness
up to 50 mm

Description	Picture	Specifications	Order Number
<p>EVOLine Square80</p> <p>1x VDE-socket, 16 A, contact protected 1x USB Charger Type A, 5V / 1A Fixed supply cable 3 m with angled plug.</p>		Cover and housing black	1592 7000 0100
		CAT 6 Socket 3.0 m Cable and plug	
		3.0 m pull out CAT 6 patch cable	1592 7000 0200
		2x USB Charger	1592 7001 6300
		without data	1592 7000 0300
		Cover and housing white	
		CAT 6 Socket 3.0 m Cable and plug	1592 7000 1900
		3.0 m pull out CAT 6 patch cable	1592 7000 2000
		2x USB Charger	1592 7001 6400
without data	1592 7000 2100		
Cover in stainless steel optics housing in black		CAT 6 Socket 3.0 m Cable and plug	1592 7000 3100
3.0 m pull out CAT 6 patch cable		1592 7000 3200	
2x USB Charger		1592 7001 6500	
without data		1592 7000 3300	

Description	Picture	Specifications	Order Number
<p>EVoline Square80 with Wireless Charger</p> <p>1x VDE-socket, 16 A, contact protected 1x USB Charger Type A, 5V / 1A 1x Wireless Charger Fixed supply cable 3 m with angled plug.</p>		<p>Cover and housing black</p> <p>3.0 m Cable and plug CAT 6 Socket</p> <p>3.0 m pull out CAT 6 patch cable</p> <p>without data</p>	<p>1592 7000 0400</p> <p>1592 7000 0500</p> <p>1592 7000 0600</p>
		<p>Cover and housing white</p> <p>3.0 m Cable and plug CAT 6 Socket</p> <p>3.0 m pull out CAT 6 patch cable</p> <p>without data</p>	<p>1592 7000 2200</p> <p>1592 7000 2300</p> <p>1592 7000 2400</p>
		<p>Cover in stainless steel optics housing in black</p> <p>3.0 m Cable and plug CAT 6 Socket</p> <p>3.0 m pull out CAT 6 patch cable</p> <p>without data</p>	<p>1592 7000 3400</p> <p>1592 7000 3500</p> <p>1592 7000 3600</p>



Wireless charging

- resonant inductive coupling between transmitter (charging station) and receiver (mobile phone)
- vendor independent, charges any Qi compatible device
- transmitter coil is active only when a connection to the receiving device is made

EVOLine® BackFlip



reddot design award
winner 2015



GERMAN
DESIGN
AWARD
NOMINEE
2016

Enhanced protection for the home.

EVoline® BackFlip

The EVoline BackFlip sits nearly flush on the work surface - when closed - the giving enhanced protection against liquid spillages. At a touch of a finger, it turns 180 degrees to reveal two power sockets and a USB charger.

The raised position provides further protection against spillages. With a total installation height of just 53 mm, the BackFlip can be fitted above most drawers, including a cutlery drawer.

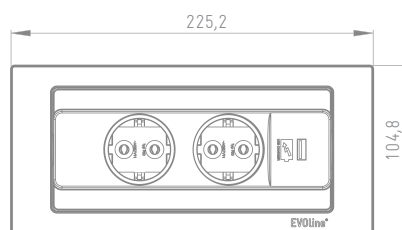
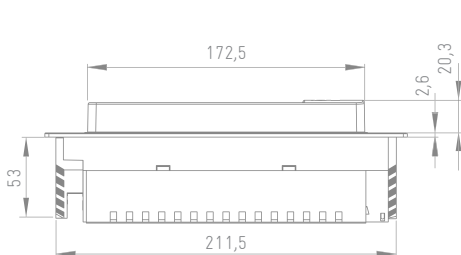

Dimensions in mm

Housing	Plastics
Cover inlay	Stainless steel, Lacquered steel, Glass
Installation	Flush-Mounted
Surface thickness	10 – 40 mm
Retractable	yes (rotation)



Fits above drawers

Assembly wedge

Rotating insert reacts at the touch of a finger



International power sockets available

USB-Charger



Installation height
53 mm

Surface variants



Brushed stainless steel



Steel: matt black lacquered





Steel: matt white lacquered



Glass: glossy black

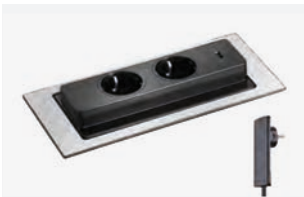

Glass: frosted white

Description	Picture	Specifications	Order Number
EVOLine BackFlip 2 × sockets, VDE-compliant, 0°, 16 A, contact-protected 1 × USB Type A Charger, 5V / 1A Fixed Power Supply Cable 3.0 m with angled plug.		Cover Brushed Stainless Steel	1592 7100 0200
		Cover Glass, frosted white	1592 7100 2000
		Cover Glass, glossy black	1592 7100 2100
		Cover matt white lacquered	1592 7100 5000
		Cover matt black lacquered	1592 7100 5100
EVOLine BackFlip with EVOLine PlugFix 2 × sockets, VDE-compliant, 0°, 16 A, contact-protected 1 × USB Type A Charger, 5V / 1A Fixed Power Supply Cable 3.0 m with EVOLine PlugFix.		Cover Brushed Stainless Steel	1592 7100 0900
		Cover Glass, frosted white	1592 7100 2200
		Cover Glass, glossy black	1592 7100 2300
EVOLine BackFlip CUISINE 2 × sockets, VDE-compliant, 0°, 16 A, contact-protected 1 × USB Type A Charger, 5V / 1 A, Fixed Power Supply Cable 2.5 m Plug supplied unattached		Cover Brushed Stainless Steel	1592 7100 0100
		Cover Glass, frosted white	1592 7100 1800
		Cover Glass, glossy black	1592 7100 1700
		Cover matt white lacquered	1592 7100 5200
		Cover matt black lacquered	1592 7100 5300

EV0line® Port Push



EVoline® Port Push

The EVoline Port Push fits virtually flush with the work surface.

By using the Push-To-Open function, the housing is released and appears above the work surface, enabling an easy pull up to connect power and data cables. With a light press of a finger, it retracts with connected leads. Slide dampers ensure a soft closing. The patented rocking cover enables a space-saving cable routing through the desk.

The Port Push modules can be assembled to customer's needs. The interchangeable data and multimedia modules allow greater flexibility, enabling future proof technology with ever changing usage requirements.

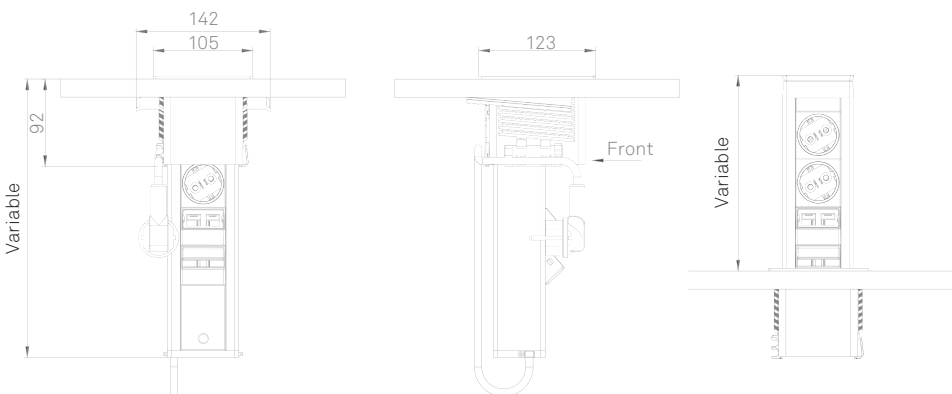

Dimensions in mm

Housing	Aluminium, anodised
Inlay for Cover and Collar	Stainless steel Glass
Installation	Flush-mounted
Surface thickness	10 – 50 mm
Interchangeable modules	25 mm
Configurable	yes
Retractable	yes (connected leads)

Push-Function facilitates the opening

Individual surfaces



Brushed Stainless Steel



Glass, black



Glass, white

International power socket modules



USB-Charger:
Charges all common devices with USB connection

Bespoke assembly with interchangeable modules to meet your requirements



A selection of interchangeable modules can be found on page 128



EVoline® Port Push

Description	Picture	Specifications	Order Number
-------------	---------	----------------	--------------

EVoline Port Push

Aluminium housing silver anodized.
 2 × sockets, VDE-compliant, 60°, 16 A, contact-protected.
 Fixed supply cable 3.0 m with angled plug.



Cover and collar in black plastic with brushed stainless steel inlay

1593 1100 0300

EVoline Port Push

Aluminium housing silver anodised.
 3 × sockets, VDE-compliant, 60°, 16 A, contact-protected
 Fixed supply cable 3.0 m with angled plug.



Cover and collar in black plastic with brushed stainless steel inlay

1593 1100 0400

Cover options



Brushed Stainless Steel



Black Glass (gloss)



White Glass (frosted)

Description	Picture	Specifications	Order Number
-------------	---------	----------------	--------------

EVOLine Port Push Cuisine

Aluminium housing, silver anodised.
 3 × sockets, VDE-compliant, 60°, 16 A, contact-protected.
 Fixed supply cable 2.5 m with wire end ferrules, plug supplied unattached.



Cover and collar in black plastic with brushed stainless steel inlay

1593 1100 0100

EVOLine Port Push Cuisine Charger

Aluminium housing, silver anodised.
 1 × USB-Charger Type A, 5V / 1A
 2 × sockets, VDE-compliant, 60°, 16 A, contact-protected.
 Fixed supply cable 2.5 m with wire end ferrules, plug supplied unattached.



Cover and collar in black plastic with brushed stainless steel inlay

1593 1100 0200

EVoline® Port *Push*

Description

Picture

Specifications

Order Number

EVoline Port Push DATA

Aluminium housing, silver anodised.
3 × sockets, VDE-compliant, 60°, 16 A, contact-protected.
2 × modular couplings CAT 6 shielded, 1:1 interconnected.
Fixed supply cable 3.0 m with angled plug.



Cover and collar in black plastic with brushed stainless steel inlay

1593 1100 0500

EVoline Port Push CHARGER

Aluminium housing, silver anodised.
2 × USBCharger Typ A, 5V / 1A
2 × sockets, VDE-compliant, 60°, 16 A, contact-protected.
Fixed supply cable 3.0 m with angled plug.



Cover and collar in black plastic with brushed stainless steel inlay

1593 1100 0600

Configure your individual EVoline Port *Push* using the EVoline Modular System

See page 6-7 for instructions

Configurable Basic Housing EVoline Port Push

Aluminium housing, silver anodised.



Cover and collar in black plastic with brushed stainless steel inlay

9332 0040 0000

Cover and collar in black plastic with frosted white glass inlay

9332 1020 0000

Cover and collar in black plastic with glossy black glass inlay.

9332 1030 0000

EVoline® Port



reddot
design award

EVoline® Port

EVoline Port let sockets and cables simply disappear. Just the collar and cover of the Port are visible on the work surface.

The easy pull-up motion let the high-quality aluminium body appear and subsequently a push-down motion let it disappear below the surface even with attached plugs. The patented rocking cover creates enough space for a cable outlet.

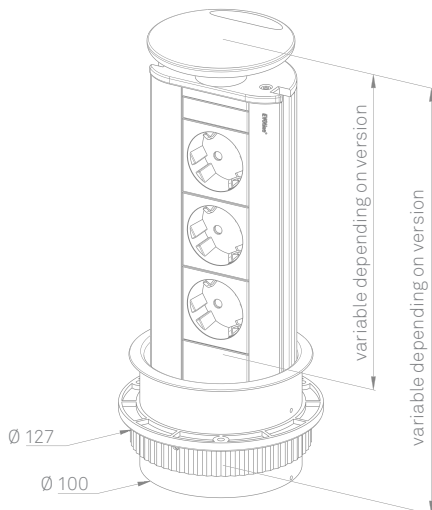

Dimensions in mm

Housing	Aluminium, anodised
Rocking Cover	Stainless steel Lacquered plastics
Collar	Lacquered plastics
Installation	Flush-mounted Diameter Ø 102 mm
Surface thickness	10 – 50 mm
Configurable	yes
Retractable	yes (connected leads)

Patented rocking cover

Individual surfaces



Silver
lacquered plastics

Stainless steel
in CD-Optics



White
lacquered plastics

Black
lacquered plastics



Chrome-plated
steel

Antique brass
lacquered plastics

NIGHTLIGHT effect



International
power socket modules





Large selection
of modules

Quick Fastener



Description	Picture	Specifications	Order Number
<p>EVOLine Port</p> <p>Aluminium housing, silver anodised.</p> <p>2× sockets, VDE-compliant, 60°, 16 A contact-protected</p> <p>Fixed supply cable 3.0 m with angled plug.</p>		<p>Rocking cover and collar made of silver lacquered plastic</p>	1593 1000 3300
<p>Rocking cover and collar made of black lacquered plastic</p>		1593 1000 5200	
<p>Rocking cover made of solid stainless steel in CD design, collar made of plastic, lacquered in stainless steel optics</p>		1593 1003 1100	
<p>Rocking cover made of solid stainless steel in CD design, collar made of plastic, lacquered in stainless steel optics.</p> <p>Blue NIGHTLIGHT effect</p>		1593 1003 1200	
<p>EVOLine Port</p> <p>Aluminium housing, silver anodised.</p> <p>3× sockets, VDE-compliant 60°, 16 A, contact-protected</p> <p>Fixed supply cable 3.0 m with angled plug.</p>		<p>Rocking cover and collar made of silver lacquered plastic</p>	1593 1000 0100
<p>Rocking cover and collar made of black lacquered plastic</p>		1593 1000 5000	
<p>Rocking cover made of solid stainless steel in CD design, collar made of plastic, lacquered in stainless steel optics</p>		1593 1002 1600	
<p>Rocking cover made of solid stainless steel in CD design, collar made of plastic, lacquered in stainless steel optics.</p> <p>Blue NIGHTLIGHT effect</p>		1593 1003 1300	

Description	Picture	Specifications	Order Number
<p>EVOLine Port Cuisine</p> <p>Aluminium housing, silver anodised.</p> <p>3× sockets, VDE-compliant, 60°, 16 A contact-protected</p> <p>Fixed supply cable 2.5 m with wire end ferrules</p> <p>Plug supplied unattached.</p>		<p>Rocking cover made of silver lacquered plastic, Collar made of grey plastic</p>	<p>1593 1000 0600</p>
<p>EVOLine Port DATA</p> <p>Aluminium housing, silver anodised.</p> <p>2× sockets, VDE-compliant, 60°, 16 A contact-protected</p> <p>Fixed supply cable 3.0 m with angled plug.</p> <p>2× modular couplings RJ45 to RJ45 CAT 6 shielded, 1:1 interconnected.</p>		<p>Rocking cover and collar made of silver lacquered plastic</p> <p>Rocking cover and collar made of black lacquered plastic</p> <p>Rocking cover made of solid stainless steel in CD design, collar made of plastic, lacquered in stainless steel optics</p> <p>Rocking cover made of solid stainless steel in CD design, collar made of plastic, lacquered in stainless steel optics. Blue NIGHTLIGHT effect</p>	<p>1593 1003 1400</p> <p>1593 1003 1500</p> <p>1593 1003 1600</p> <p>1593 1003 1700</p>

Description	Picture	Specifications	Order Number	
<p>EVOLine Port DATA</p> <p>Aluminium housing, silver anodised.</p> <p>3× sockets, VDE-compliant, 60°, 16 A contact-protected.</p> <p>2× Cat. 6 modular couplings</p> <p>Fixed supply cable 3.0 m with angled plug.</p>		<p>Rocking cover and collar made of silver lacquered plastic</p>	1593 1003 1800	
			<p>Rocking cover and collar made of black lacquered plastic</p>	1593 1003 1900
			<p>Rocking cover made of solid stainless steel in CD design, collar made of plastic, lacquered in stainless steel optics</p>	1593 1003 2000
			<p>Rocking cover made of solid stainless steel in CD design, collar made of plastic, lacquered in stainless steel optics.</p> <p>Blue NIGHTLIGHT effect</p>	1593 1003 2100
<p>EVOLine Port USB CHARGER</p> <p>Aluminium housing, silver anodised.</p> <p>2x sockets, VDE-compliant, 60°, 16 A, contact-protected.</p> <p>1x USB Type A Charger, 5V / 1 A</p> <p>Fixed supply cable 3.0 m with angled plug.</p>		<p>Rocking cover and collar made of silver lacquered plastic</p>	1593 1040 0200	
			<p>Rocking cover and collar made of black lacquered plastic</p>	1593 1040 0300
			<p>Rocking cover made of solid stainless steel in CD design, collar made of plastic, lacquered in stainless steel optics</p>	1593 1040 0400
<p>EVOLine Port 2x USB CHARGER</p> <p>Aluminium housing, silver anodised.</p> <p>3x sockets, VDE-compliant, 60°, 16 A, contact-protected</p> <p>2× USB-Charger Type A, 5V / 1 A</p> <p>Fixed supply cable 3.0 m with angled plug.</p>		<p>Rocking cover and collar made of silver lacquered plastic</p>	1593 1038 4100	
			<p>Rocking cover and collar made of black lacquered plastic</p>	1593 1038 7100
			<p>Rocking cover made of solid stainless steel in CD design, collar made of plastic, lacquered in stainless steel optics</p>	1593 1038 7200

Description	Picture	Specifications	Order Number
-------------	---------	----------------	--------------

Configure your individual EVoline Port using the EVoline Modular System

See page 6-7 for instructions

Configurable Basic Housing EVoline Port

Aluminium housing
silver anodised.

Mounting hole \varnothing 102 mm.



Rocking cover and collar
made of silver lacquered
plastic

9330 1830 0000

Rocking cover made of
solid stainless steel in CD
design, collar made of pla-
stic, lacquered in stainless
steel optics

9330 1360 0000

Configurable Basic Housing EVoline Port CLASSIC

Aluminium housing
plated in antique brass colour.

Mounting hole \varnothing 102 mm



Rocking cover and collar
made of antique brass
lacquered plastic

9330 2710 0000

Configurable Basic Housing EVoline Port CHROME

Chrome plated aluminium housing

Mounting hole \varnothing 102 mm.



Rocking cover made of
chromed steel,
collar made of black
lacquered plastic

9330 2750 0000

Configurable Basic Housing EVoline Port BLACK

Aluminium housing
black anodised.

Mounting hole \varnothing 102 mm.



Rocking cover and collar
made of black lacquered
plastic

9330 5560 0000

Nightlight LED Modul for EVoline Port

LEDs underneath rocking cover



Light colour: night blue

9330 3830 0000

Light colour: ruby red

9330 3840 0000

Light colour: emerald green

9330 5790 0000

Light colour: soft white

9331 0260 0000

EVoline® FlipTop Push



A touch of a finger is sufficient.

EVoline® FlipTop Push

The FlipTop Push is an elegant solution supplying all work areas with power, data and multimedia.

Interchangeable modules for data and multimedia ensure unlimited flexibility for future requirements at the workspace.

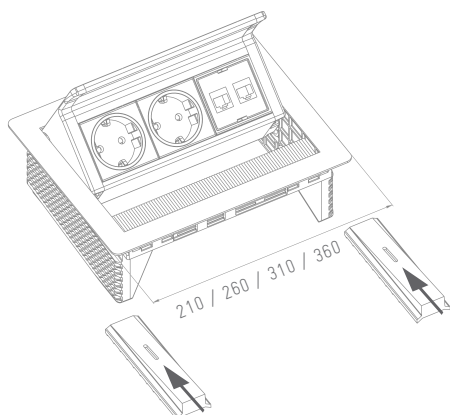

Dimensions in mm

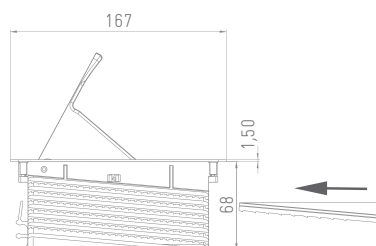

Housing	Aluminium, anodised or powder-coated
Cover	Stainless steel brushed, powder-coated
Installation	Flush-Mounted (Height 68 mm)
Surface thickness	10 – 50 mm
Configurable	yes

A selection of interchangeable modules can be found on page 128.

Simple and quick exchange of modules. Customisable with interchangeable modules.



Push-to-open function

Final open position with manual locking mechanism allows easy insertion of plugs.



International power socket modules



Quick installation, for surface thickness up to 50 mm







Adaptor clip for safe connection to WireLane



Convenient cable routing ensures tidiness below the table

EVoline® FlipTop Push

Description	Picture	Specifications	Order Number
<p>EVoline FlipTop Push S</p> <p>3× sockets, VDE-compliant 60°, 16 A, contact-protected Fixed supply cable 3.0 m with angled plug. Installation dimensions: 157 × 195 mm</p>		<p>Housing made of black anodised aluminium Cover brushed stainless steel</p>	1593 7002 4900
<p>EVoline FlipTop Push Data S</p> <p>2× sockets, VDE-compliant, 60°, 16 A, contact-protected. 2× Cat.6 modular couplings, shielded Fixed supply cable 3.0 m with angled plug. Installation dimensions: 157 × 195 mm</p>		<p>Housing made of black anodised aluminium Cover brushed stainless steel</p>	1593 7002 8100
<p>EVoline FlipTop Push M</p> <p>4× sockets, VDE-compliant, 60°, 16 A, contact-protected. Fixed supply cable 3.0 m with angled plug. Installation dimensions: 157 × 245 mm</p>		<p>Housing made of black anodised aluminium Cover brushed stainless steel</p>	1593 7000 2700
<p>EVoline FlipTop Push M</p> <p>2× sockets, VDE-compliant, 60°, 16 A, contact-protected. 2× installation space for interchangeable modules Fixed supply cable 3.0 m with angled plug. Installation dimensions: 157 × 245 mm</p>		<p>Housing made of black anodised aluminium Cover brushed stainless steel</p>	1593 7010 1400
<p>EVoline FlipTop Push Data M</p> <p>3× sockets, VDE-compliant, 60°, 16 A, contact-protected. 2× Cat.6 modular couplings, shielded Fixed supply cable 3.0 m with angled plug. Installation dimensions: 157 × 245 mm</p>		<p>Housing made of black anodised aluminium Cover brushed stainless steel</p>	1593 7000 0200

Description	Picture	Specifications	Order Number
-------------	---------	----------------	--------------

Configure your individual EVoline FlipTop *Push* using the EVoline Modular System

See page 6-7 for instructions

Configurable Basic Housing EVoline FlipTop Push S

For 3 modules
Housing made of black anodised aluminium,
Installation dimensions: 157 × 195 mm



Cover brushed stainless steel	9331 8010 0000
black powder-coated	9331 9360 0000
white powder-coated	9331 9630 0000
grey powder-coated	9331 9670 0000

Configurable Basic Housing EVoline FlipTop Push M

For 4 modules
Housing made of black anodised aluminium,
Incl. WireLane Adaptor
Installation dimensions: 157 × 245 mm

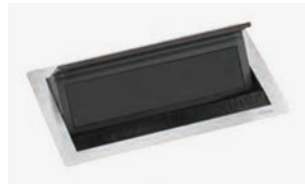

Cover brushed stainless steel	9331 8020 0000
black powder-coated	9331 9370 0000
white powder-coated	9331 9640 0000
grey powder-coated	9331 9680 0000

Configurable Basic Housing EVoline FlipTop Push L

For 5 modules
Housing made of black anodised aluminium,
Incl. WireLane Adaptor
Installation dimensions: 157 × 295 mm



Cover brushed stainless steel	9331 8030 0000
black powder-coated	9331 9380 0000
white powder-coated	9331 9650 0000
grey powder-coated	9331 9690 0000

Configurable Basic Housing EVoline FlipTop Push XL

For 6 Modules
Housing made of black anodised aluminium,
Incl. WireLane Adaptor
Installation dimensions: 157 × 345 mm

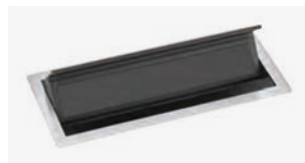

Cover brushed stainless steel	9331 8040 0000
black powder-coated	9331 9390 0000
white powder-coated	9331 9660 0000
grey powder-coated	9331 9700 0000



Configurable Basic Housing EVoline FlipTop Push white

For 3-6 Modules
Housing made of white powder-coated aluminium,
cover white powder-coated,
Incl. WireLane Adaptor



S	9332 3980 0000
M	9332 3990 0000
L	9332 4000 0000
XL	9332 4010 0000

EVoline® FlipTop Push

Description	Picture	Specifications	Order Number
<p>EVoline WireLane Adaptor</p> <p>To connect WireLane to FlipTop Push.</p>			1599 0910 3300
<p>EVoline FlipTop Push TRAY</p> <p>black powder-coated. For protection and cover below the table. Also applicable as cable tray.</p>		<p>for FlipTop Push S</p> <p>for FlipTop Push M</p> <p>for FlipTop Push L</p> <p>for FlipTop Push XL</p>	<p>1599 0910 8600</p> <p>1599 0910 8700</p> <p>1599 0910 8800</p> <p>1599 0910 8900</p>

Surface- / Colour-variations



Brushed stainless steel



Steel: black powder coated



Steel: gray powder coated



Steel: white powder coated

EVoline® FrameDock



A flexible modular system for various applications.

EVoline® FrameDock

EVoline FrameDock is a flush fitting system which can be installed horizontally or vertically - be it on a desk, a kitchen worktop, a wall, or a side of a piece of furniture. It can be mounted almost everywhere due to its low mounting depth of 51 mm and installation from the top:

High quality design, customisable components and yet discreet.

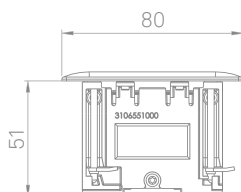
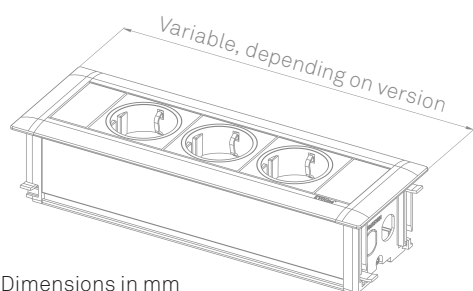

Dimensions in mm

Profile	Aluminium, anodised or powder-coated
Screw Cover	Plastics
Installations	Flush-Mounted (51 mm)
Surface thickness	5 – 38 mm
Configurable	yes

Examples of power supply options:

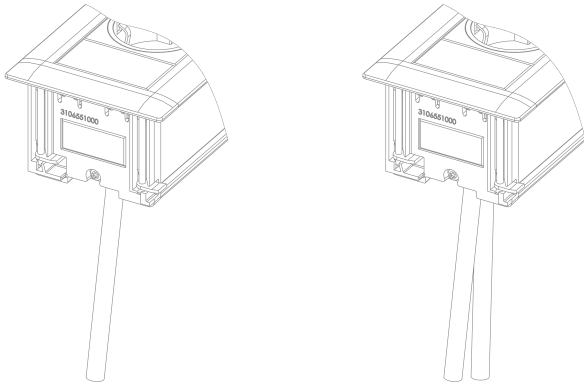

Fixed Power Supply Cable through the bottom of the profile

Available with several country specific plugs, with wire end ferrules, Wieland GST 18i3, or WAGO WINSTA connector

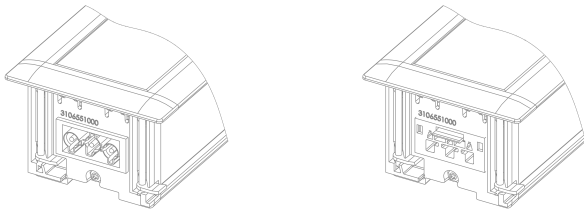

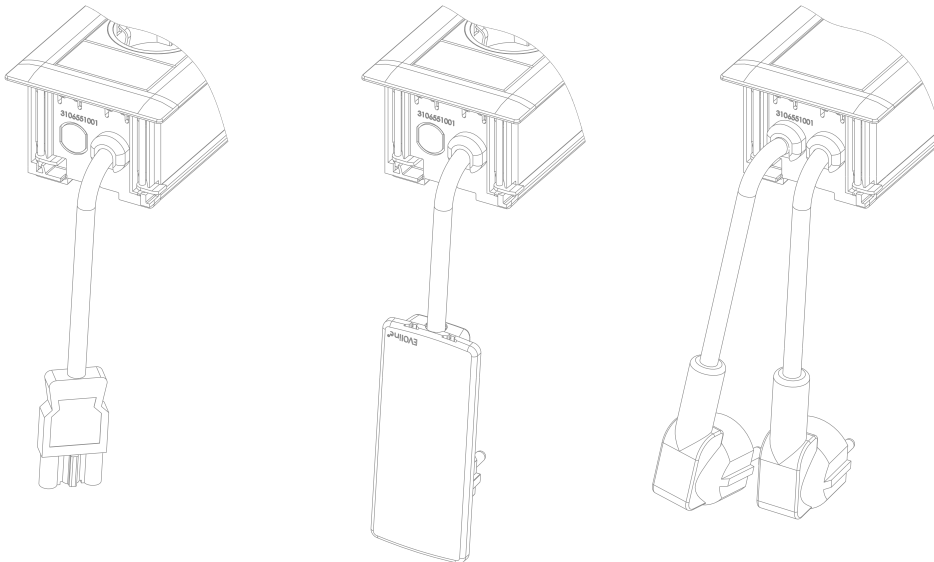

End cap with power input or output connector, depending on the surface thickness (max. 18 mm)



End cap with fixed power supply cable, depending on the surface thickness (max. 18 mm)

Available with several country specific plugs, EVoline Plug, wire end ferrules, Wieland GST 18- or WAGO WINSTA connector.

Description	Picture	Specifications	Order Number
<p>EVoline FrameDock SMALL</p> <p>Aluminium housing, silver anodised, 3× sockets, VDE-compliant, 0°, 16 A, contact-protected. Fixed supply cable 3.0 m with angled plug. Powersupply cable entry left side in the bottom of the profile.</p> <p>Installation Dimensions: 71 mm × 225 mm</p>		Profile silver anodised Screw covers black plastic	1596 1000 0900
		Profile black Screw covers black plastic	1596 1001 9500
		Profile white Screw covers white plastic	1596 1001 7900
<p>EVoline FrameDock DATA SMALL'</p> <p>Aluminium housing, silver anodised 3× sockets, VDE-compliant, 0°, 16 A, contact-protected. Fixed supply cable 3.0 m with angled plug. 2× Cat.6 modular couplings Power and data cable entry in the bottom of the profile.</p> <p>Installation Dimensions: 71 mm × 280 mm</p>		Profile silver anodised Screw covers black plastic	1596 1000 1000
		Profile black Screw covers black plastic	1596 1001 9600
		Profile white Screw covers white plastic	1596 1001 8000

Configure your individual EVoline FrameDock using the EVoline Modular System

See page 6-7 for instructions

Configurable Basic Housing FrameDock
For surface thickness up to 38 mm



Profile silver anodised Screw covers black plastic	9331 2180 0000
Profile Silver anodised Screw covers silver lac- quered plastic	9331 2550 0000
Profile black anodised Screw covers black plastic	9331 5330 0000
Profile white powder- coated Screw covers white plastic	9331 3540 0000

EVOLine[®] Dock Square



EVoline[®] Dock Square

EVoline Dock Square, the modern generation of on-Desk systems, provides a mobile, compact and flexible solution for the workspace.

Starting with the Dock Square Basic up to the individually configurable versions, interchangeable modules for Data and Multimedia facilitate timeless and almost unlimited flexibility as connectivity requirements evolve.

An easy adhesive fixing simplifies the installation. The adhesive connection is removable at any time enabling the Dock Square to be placed in another position. Even on Glass!

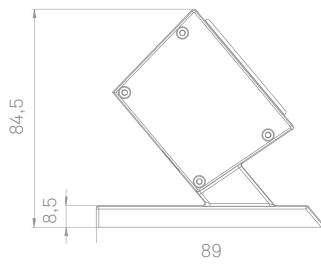
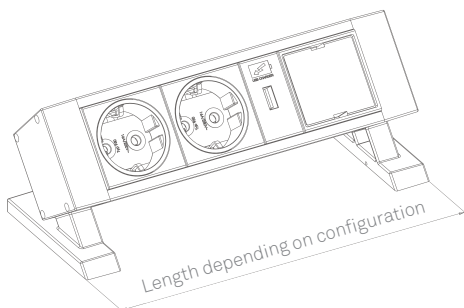

Housing	Aluminium, anodised or powder-coated
Installation	On-Desk Mounted Free arrangeable
Interchangeable modules	50 mm
Configurable	yes

Simple and quick exchange of modules. Customisable with interchangeable modules.



A selection of interchangeable modules can be found on page 128.



International socket modules



Cable connections are easily accessible.



Simple cable-routing.

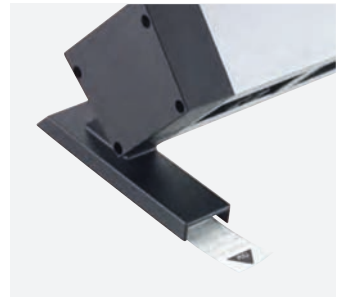

Fast fixing and removal with double sided strips

EVoline® Dock Square

Description	Picture	Specifications	Order Number
-------------	---------	----------------	--------------

EVoline Dock Square

Aluminium housing.
 2 × VDE Sockets 0°, 16 A
 1 × USB-Charger Type A, 5V / 1A
 1 × Installation Space
 2× Double sided strips.
 Fixed supply cable 3.0 m with GST18 plug
 Dimensions (W × H × D):
 220 × 85 × 89 mm



Housing
 silver anodised

1593 8000 0100

EVoline Dock Square suitable for FUJITSU Port Replicator PR09

Aluminium housing.
 1× VDE Socket 0°, 16 A
 1× VDE Socket 60°, 16 A
 1 × cable outlet
 1 × on / off switch
 2 × Double sided strips for table mounting.
 Fixed mains cable 3 m with VDE angle plug
 Output cable 0.5 m with GST 18 socket



Housing
 silver anodised

1593 8100 0400

Dimensions (W × H × D):
 244 × 97,5 × 115 mm

Configure your personal EVoline Dock Square in the EVoline Construction Set

See page 6-7 for instructions

Configurable Basic Housing EVoline Dock Square

Aluminium housing.
 2× Double sided strips.



Housing
 silver anodised

9332 0720 0000

black anodised

9332 0730 0000

white powder coated

9332 1170 0000

Double Sided Strips for EVoline Dock Square

2× Double sided strips



9332 1050 0000

*The USB charging function cannot be guaranteed due to the multitude of manufacturers and devices on the market.

Technical changes and printing errors reserved. | Similar pictures.

EVoline[®] Dock



Above desk quality for home, office, hotel.

EVoline® Dock

EVoline Dock sits above the desk allowing maximum workspace. Various fixing options are available like EVoline Quicklock, clamps, pillars, etc.

The configurable charging and data station can be equipped with the complete EVoline Modules range.

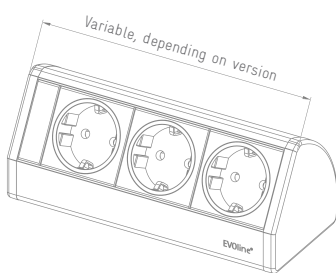

Dimensions in mm

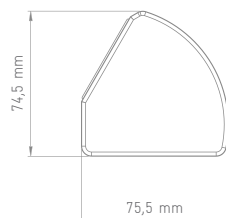

Profile	Aluminium, anodised or powder-coated
End Caps	Plastics
Installation	On-Desk-Mounted (Mounting-set, Mounting-clamps)
Configurable	yes

Examples of power supply options:

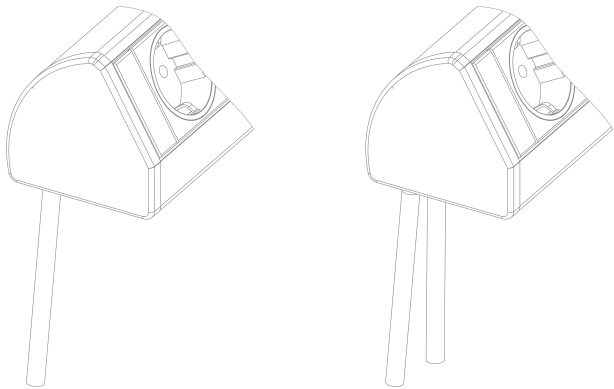

Fixed Power Supply Cable through the bottom of the profile

Available with several country specific plugs, with wire end ferrules, Wieland GST 18i3, or WAGO WINSTA Connector

Color of the end caps painted to match the profiles color.

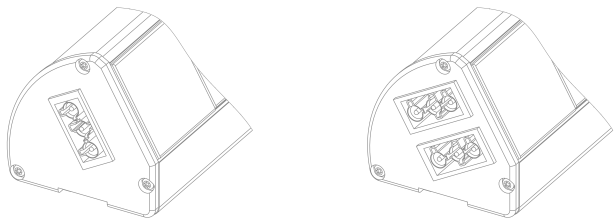

End cap with power input and/or output connector, depending on the surface thickness (max. 18 mm)

End cap colour: black

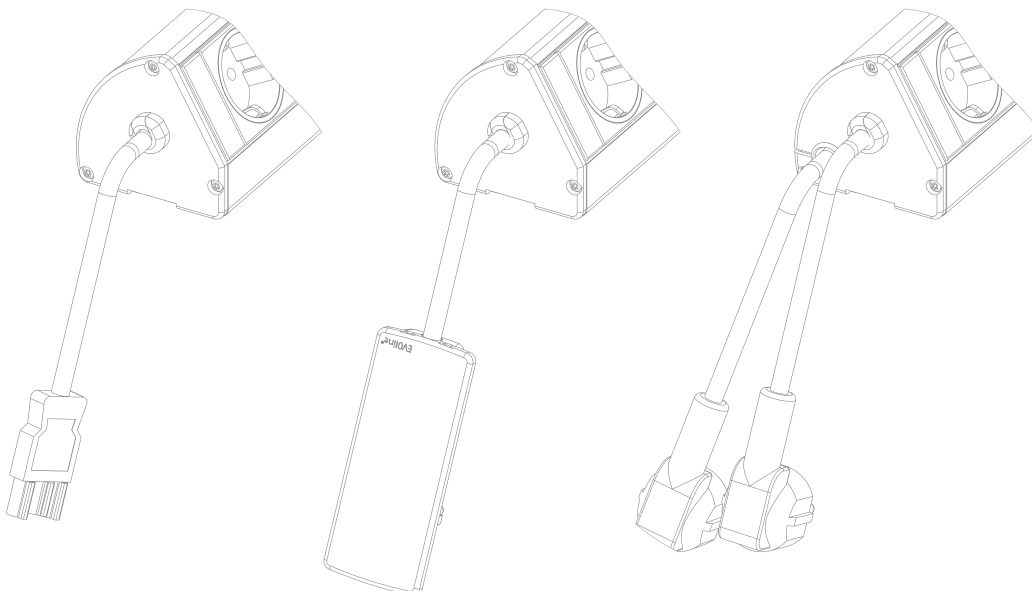

End cap with fixed power supply cable.

Available with several country specific plugs, EVoline Plug, wire end ferrules, Wieland GST 18 or WAGO WINSTA Connector.

Color of the end caps: black

Description	Picture	Specifications	Order Number
<p>EVoline Dock CUISINE</p> <p>Aluminum housing, anodised in colour stainless steel (ALANOX®) End caps lacquered to match the frame color, supplied unattached. Outlet receptacles painted to match the color profile. 3× VDE sockets with 2.5 m supply cable with wire end ferrules. VDE plug supplied unattached. Mounting set for under desk installation attached.</p>		<p>Stainless steel anodised (ALANOX®)</p>	<p>1593 0368 3600</p>
<p>EVoline Dock DESK</p> <p>Aluminium housing, free positioning with provided slide stops. 3x sockets, VDE compliant, 0°, 16 A, contact-protected. Fixed supply cable 3.0 m with angled plug. Power supply cable entry in the left end cap.</p>		<p>Silver anodised</p> <p>Black anodised</p> <p>White powder-coated</p>	<p>1593 0004 0300</p> <p>1593 0004 0100</p> <p>1593 0004 0700</p>
<p>EVoline Dock DESK DATA</p> <p>Aluminium housing, free positioning with provided slide stops. 3× sockets, VDE-compliant, 0°, 16 A, contact-protected. Fixed supply cable 3.0 m with angled plug. 2× Cat.6 modular couplings Power supply cable entry in the left end cap.</p>		<p>Silver anodised</p> <p>Black anodised</p> <p>White powder-coated</p>	<p>1593 0047 8300</p> <p>1593 0047 8100</p> <p>1593 0047 8700</p>

Description	Picture	Specifications	Order Number
EVoline Dock SMALL		With 2 mounting clamps for surfaces thickness 8 – 40mm	
<p>Aluminium housing. 3× sockets, VDE compliant, 0°, 16 A, contact-protected. Fixed supply cable 3.0 m with angled plug. Power supply cable entry left side in the bottom of the profile.</p>		Silver anodised	1593 0066 6300
		Black anodised	1593 0066 6100
		White powder-coated	1593 0066 6700
		Without mounting clamps	
		Silver anodised	1593 0003 9300
	Black anodised	1593 0003 9100	
	White powder-coated	1593 0003 9700	
EVoline Dock DATA SMALL		With 2 mounting clamps for surfaces thickness 8 – 40mm	
<p>Aluminium housing, 3× sockets, VDE-compliant, 0°, 16 A, contact-protected. Fixed supply cable 3.0 m with angled plug. 2× modular couplings RJ45 to RJ45 Cat.6 shielded, 1:1 interconnected. Power and data cable entry in the bottom of the profile.</p>		Silver anodised	1593 0066 2300
		Black anodised	1593 0066 2100
		White powder-coated	1593 0066 2700
		With QuickLock Pro 150 mm	
		Silver anodised	1593 0394 4300
	Black anodised	1593 0394 4100	
	White powder-coated	1593 0394 4700	
	Without mounting clamps		
	Silver anodised	1593 0047 7300	
	Black anodised	1593 0047 7100	
	White powder-coated	1593 0047 7700	

Description

Picture

Specifications

Order Number

Configure your individual EVoline Dock using the EVoline Modular System

See page 6-7 for instructions

Configurable Basic Housing EVoline Dock BLACK

Aluminium housing
Cable entry through end cap or
profile.



Black anodised

9330 1811 0000

Configurable Basic Housing EVoline Dock SILVER

Aluminium housing
Cable entry through end cap or
profile.



Silver anodised

9330 1810 0000

Configurable Basic Housing EVoline Dock STAINLESS

Aluminium housing
Cable entry through end cap or
profile.



Stainless steel alike
anodised (ALANOX®)

9330 8450 0000

Configurable Basic Housing EVoline Dock WHITE

Aluminium housing
Cable entry through end cap or
profile.



White powder-coated
End caps plastic laquered
to match
(in case cable entry
through the profile)

9331 3530 0000

EV0line® R-Dock



Contemporary and modern for all workspaces.

EVoline® R-Dock

EVoline R-Dock can be installed into any right-angled corner.

With its flat back and angled front fascia, it is comfortable to use. Freely configurable.

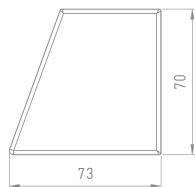
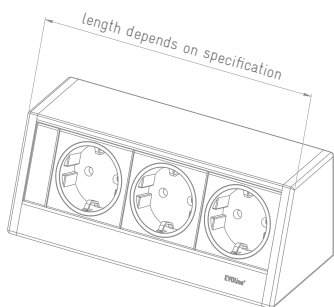

Dimensions in mm

Profile	Aluminium, anodised or powder-coated
End Caps	Plastics
Installation	On-Desk-Mounted (Mounting-set, Mounting-clamps)
Configurable	yes

Examples of power supply options:

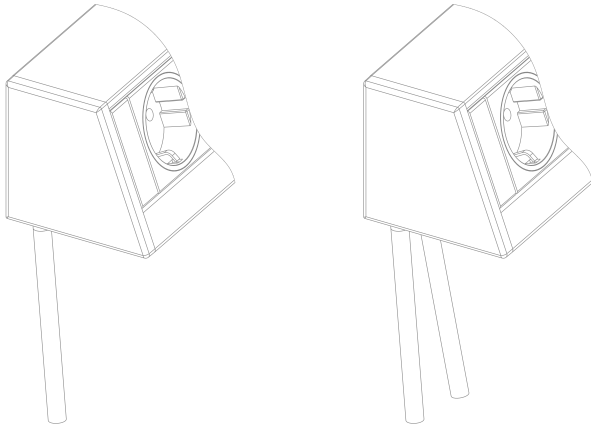

Fixed Power Supply Cable through the bottom of the profile

Available with several country specific plugs, with wire end ferrules, Wieland GST 18i3, or WAGO WINSTA Connector

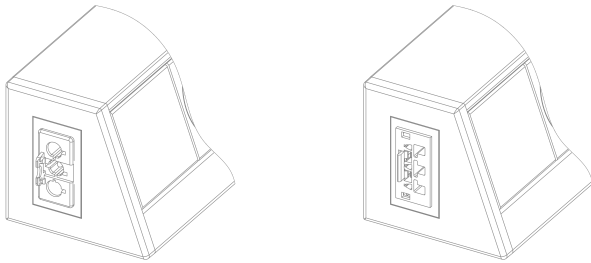

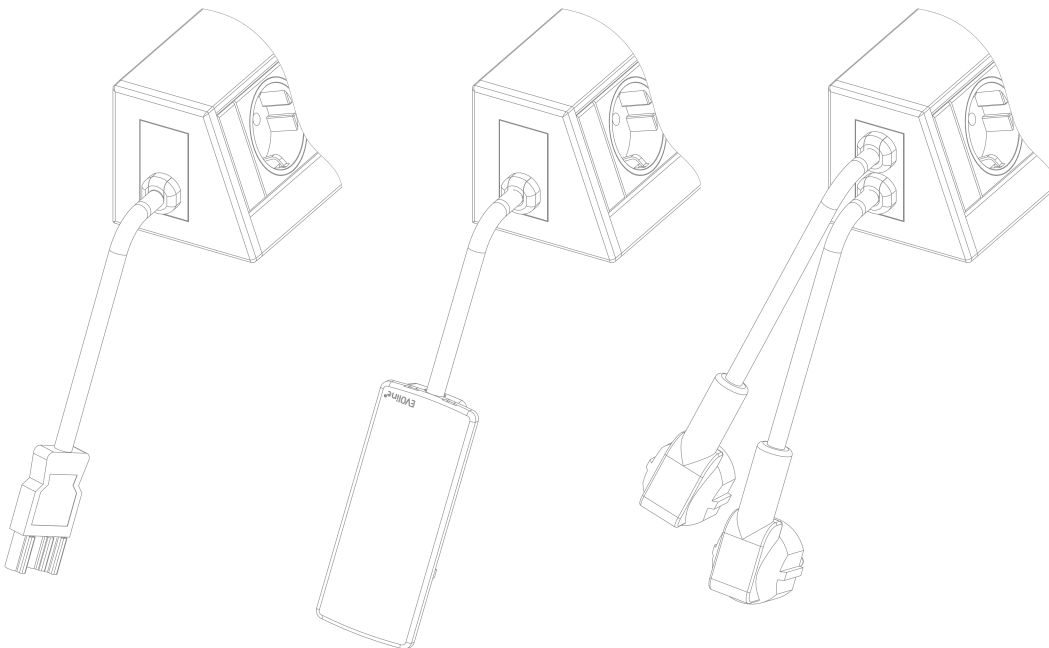

End cap with Wieland GST 18i3, or WAGO WINSTA power input or output connector.



End cap with fixed power supply cable

Available with several country specific plugs, EVOLine Plug, wire end ferrules, Wieland GST 18i3- or WAGO WINSTA Connector.

EVOLine® R-Dock

Description	Picture	Specifications	Order Number
<p>EVOLine R-Dock SMALL</p> <p>Aluminium housing, 3× sockets, VDE-compliant, 0°, 16 A, contact-protected. Fixed supply cable 3.0 m with angled plug. Power supply cable entry on the left side in the bottom of the profile.</p>		<p>Silver anodised</p> <p>White powder-coated</p>	<p>1598 0000 1700</p> <p>1598 0000 8600</p>
<p>EVOLine R-Dock DATA SMALL</p> <p>Aluminium housing, 3× sockets, VDE-compliant, 0°, 16 A, contact-protected. Fixed supply cable 3.0 m with angled plug. 2× Cat.6 modular couplings Power and data cable entry in the bottom of the profile.</p>		<p>Silver anodised</p> <p>White powder-coated</p>	<p>1598 0000 1800</p> <p>1598 0000 8700</p>

Configure your individual EVOLine R-Dock using the EVOLine Modular System

See page 6-7 for instructions

Configurable Basic Housing EVOLine R-Dock

Aluminium housing.
Power supply cable entry through
end cap or profile.



Silver anodised 9331 0620 0000

Configurable Basic Housing EVOLine R-Dock

Aluminium housing.
Power supply cable entry through
end cap or profile.



White powder-coated 9331 4340 0000

EVoline® T-Dock



At home in the kitchen.

EVoline® T-Dock

The EVoline T-Dock is raised above the work surface by its solid stainless steel pillar. This gives clutter free space and creates a safe distance between power supply and potentially wet surfaces in the kitchen.

The power supply cable is routed through the stained steel pillar which is also a high quality anti-theft device since it is firmly screwed beneath the surface.

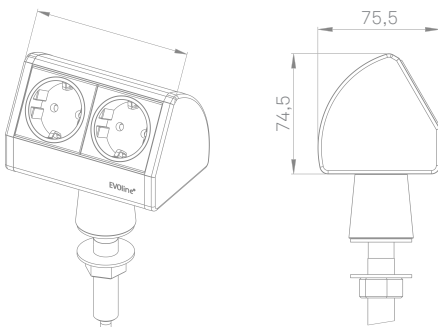

Dimensions in mm

Profile	Aluminium, anodised or powder-coated
End Caps	Plastics
Installation	Mounted with Steel Pillar
Surface thickness	max. 40 mm

Examples for power supply of the T-Docks:

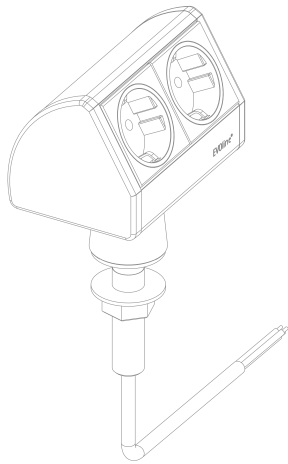

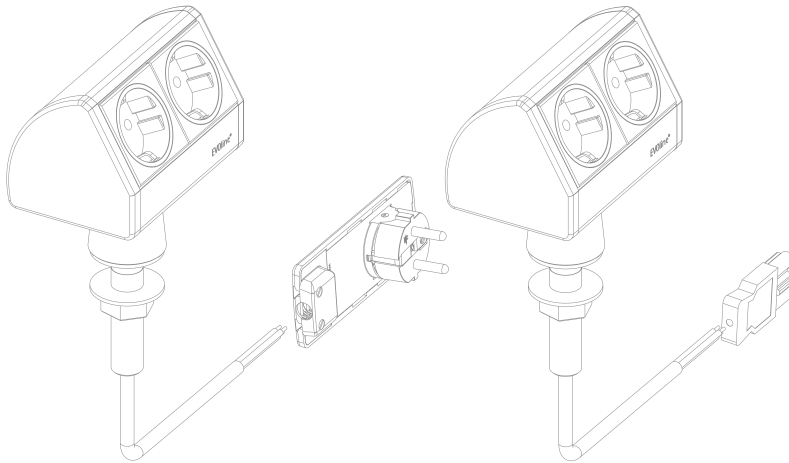

Fixed Power Supply Cable
routed through the stain-
less steel pillar.



Fixed Power Supply Cable
routed through the stain-
less steel pillar.

Available with several
country specific plugs,
EVoline Plug, wire end
ferrules,
Wieland GST 18i3- or
WAGO WINSTA Connector.

EVOLine® T-Dock

Description	Picture	Specifications	Order Number
<p>EVOLine T-Dock</p> <p>Aluminium housing in stainless steel optics, ALANOX®. For surface thickness up to 50 mm. 2× sockets, VDE-compliant, 0°, 16 A, contact-protected. Fixed supply cable with ferrules, plug supplied unattached. Power supply cable entry through the stainless steel pillar.</p>		<p>Housing stainless steel alike anodised (ALANOX®) Plastic end caps lacquered in black</p> <p>Housing stainless steel alike anodised (ALANOX®) Plastic end caps lacquered in stainless steel optics, ALANOX®</p>	<p>1593 0220 5600</p> <p>1593 0345 5600</p>
<p>EVOLine T-Dock with USB Charger</p> <p>1× socket, VDE-compliant, 0°, 16 A, contact-protected. 1x USB-Charger Type A, 5V / 1A Fixed supply cable with ferrules, plug supplied unattached. Power supply cable entry through the stainless steel pillar.</p>		<p>Housing stainless steel alike anodised (ALANOX®) Plastic end caps lacquered in black</p> <p>Housing stainless steel alike anodised (ALANOX®) Plastic end caps lacquered in stainless steel optics, ALANOX®</p>	<p>1593 0387 4600</p> <p>1593 0387 5600</p>

EVOLine[®] V-Dock



EVoline® V-Dock

The EVoline V-Dock gives dead corners a benefit.

It can be installed horizontally or vertically and is variable in length. In addition, the supply cable is concealed using the space between the back of the profile and the wall corner.

Thanks to the V-Docks 45 degree alignment power and data cables are easy to connect.

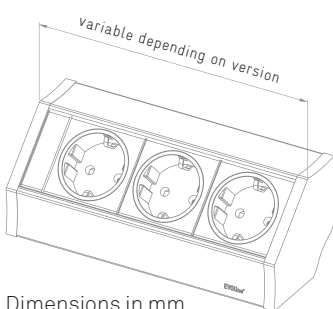

Dimensions in mm

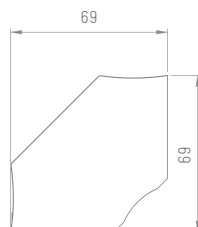

Profile	Aluminium, anodised
End Caps	Plastics
Installation	Angle-Mounted (Angled profiles)
Configurable	yes

Examples of power supply options:

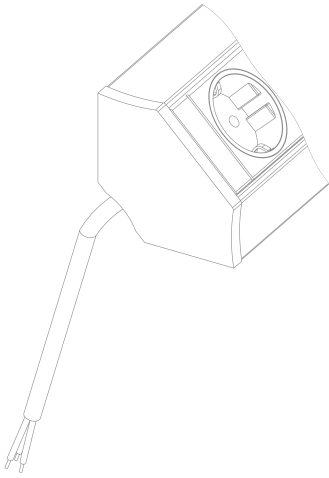

End cap with power input and/or output connector.

End cap with fixed power supply cable.

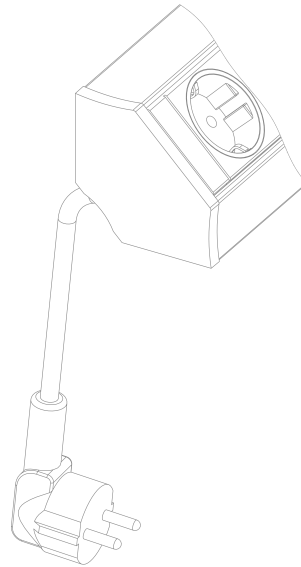
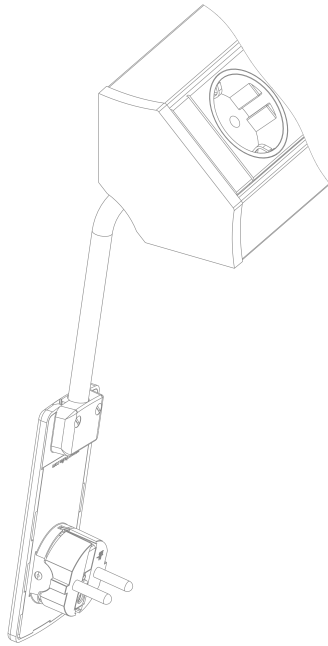
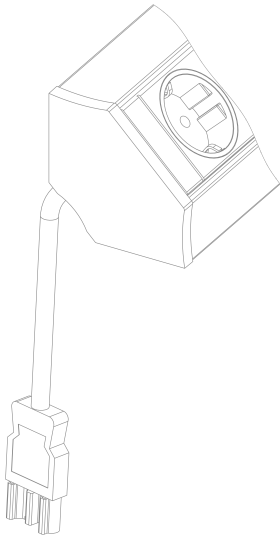

Available with several country specific plugs, EVOLine Plug, wire end ferrules, Wieland GST 18i3- or WAGO WINSTA Connector.

End cap colour: black



All above mentioned U-Dock end caps are available with or without mounting angles.

EVoline® V-Dock

Description	Picture	Specifications	Order Number
<p>EVoline V-Dock CUISINE</p> <p>Aluminium housing, 3× sockets, VDE-compliant, 0°, 16 A, contact-protected. Fixed supply cable 2.5 m with fer- rules, plug supplied unattached. Incl. profile bracket 100 mm.</p>		Silver anodised	1593 6000 1300
<p>EVoline V-Dock DATA SMALL</p> <p>Aluminium housing, 3× sockets, VDE-compliant, 0°, 16 A, contact-protected. 2× modular couplings RJ45 to RJ45 Cat.6 shielded, 1:1 interconnected. Fixed supply cable 3 m with angled plug. Incl. 2 profile brackets 100 mm.</p>		Silver anodised	1593 6000 2300

Configure your individual EVoline V-Dock using the EVoline Modular System

See page 6-7 for instructions

Configurable Basic Housing EVoline V-Dock

Aluminium housing
From a length of 250 mm,
2 profile brackets of 100 mm are
required for fixing.



Silver anodised

9330 5600 0000

Configurable Basic Housing EVoline V-Dock

Aluminium housing
From a length of 250 mm,
2 profile brackets of 100 mm are
required for fixing.



Black anodised

9331 5850 0000

EVoline® V-Port



reddot design award
winner 2015



Connectivity for corners everywhere.

EVoline® V-Port

In kitchens, you often find unused space underneath a wall cabinet, in corners and next to tall cupboards. This is where the EVoline V-Port can be installed.

In its closed position, the V-Port is concealed behind a discreet and elegant aluminium cover in stainless steel optics. A gentle touch releases a multiple socket rail. As option available with USB charger.

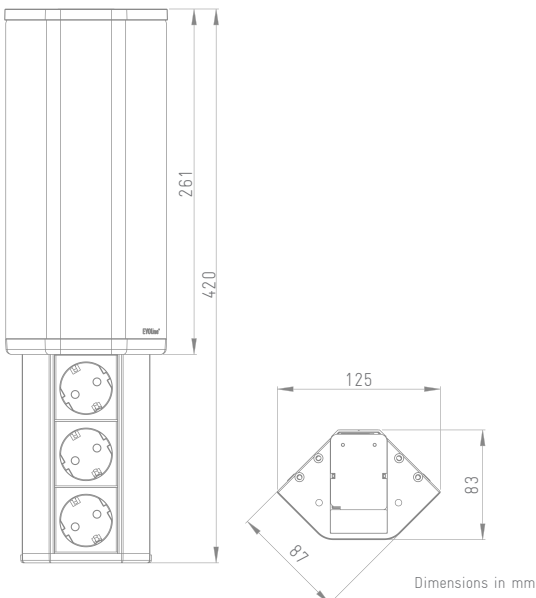

Housing	Aluminium
Cover	Aluminium
Installation	Angle - Mounted Flush-Mounted
Retractable	yes

Quick mounting,
Easy connection
via special connector



EVoline VDE Plug
is standard

Soft Touch
release



International
power socket
versions available

USB-Charger
optional

EVOLine® V-Port

Description	Picture	Specifications	Order Number
<p>EVOLine V-Port 2-gang</p> <p>2× VDE-compliant socket, 60°, 16 A, contact-protected. Power supply cable 2.5 m with plug-in connector. All configurations with VDE-compliant sockets with fixed EVOLine Plug. Other versions with wire end ferrules and country-specific plug, supplied unattached.</p>		Aluminum cover in stainless steel optics	1593 4500 0200
<p>EVOLine V-Port 3-gang</p> <p>3× VDE-compliant sockets, 60°, 16 A, contact-protected. Power supply cable 2.5 m with plug-in connector. All configurations with VDE-compliant sockets with fixed EVOLine Plug. Other versions with wire end ferrules and country-specific plug, supplied unattached.</p>		Aluminum cover in stainless steel optics	1593 4500 0100
<p>EVOLine V-Port 2-gang with USB-Charger</p> <p>2× VDE-compliant sockets, 60°, 16 A, contact-protected 1x USB Type A Charger, 5V / 1 A Supply cable 2.5 m with plug-in connector. All configurations with VDE-compliant sockets with fixed EVOLine Plug. Other versions with wire end ferrules and country-specific plug, supplied unattached.</p>		Aluminum cover in stainless steel optics	1593 4500 0300

EVOLine® U-Dock



EVoline[®] U-Dock

EVoline U-Dock can be mounted to any work surface in various ways.

As a robust base for a professional power and data supply, the freely configurable aluminium profile can be equipped with various power and data modules as well as safety devices for protection of personnel and machinery.

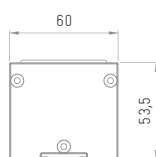
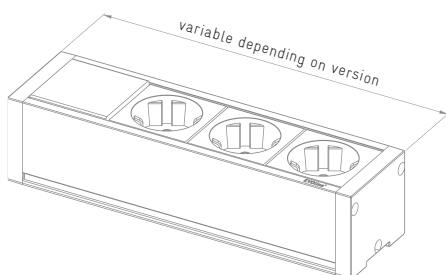

Dimensions in mm

Profile	Aluminium, anodised
End Caps	Plastics
Installation	On-Desk-Mounted (Mounting-angles)
Configurable	yes

Examples of power supply options:

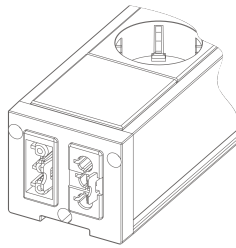
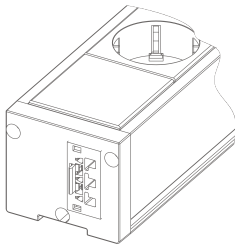

End cap with
Wieland GST 18i3, or
WAGO WINSTA power input
or output connector.

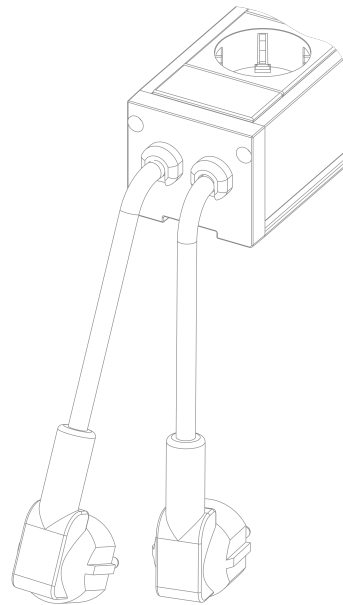
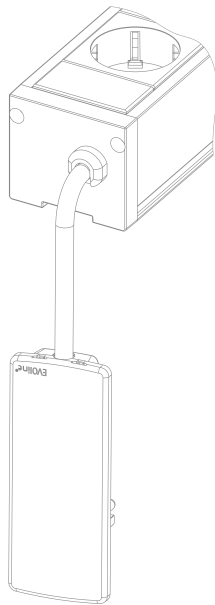
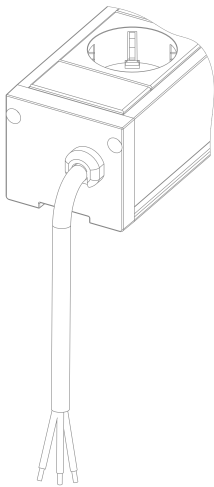

End cap with fixed power
supply cable.

Available with several
country specific plugs,
EVOLine Plug, wire end
ferrules,
Wieland GST 18i3- or
WAGO WINSTA Connector.

End cap colour: black

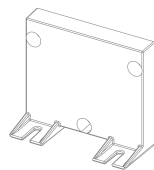
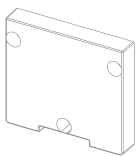

All above mentioned
U-Dock end caps are
available with or without
mounting angles.

EVOLine® U-Dock

Description	Picture	Specifications	Order Number
<p>EVOLine U-Dock SMALL</p> <p>Aluminium housing, 3× sockets, VDE-compliant, 60°, 16 A, contact-protected. Power input and output connector GST18i3 plug and GST18i3 socket.</p>		<p>Silver anodised with mounting angles</p> <p>Silver anodised without mounting angles</p>	<p>1596 0000 9500</p> <p>1596 0000 9600</p>
<p>EVOLine U-Dock DATA SMALL</p> <p>Aluminium housing, 3× sockets, VDE-compliant, 60°, 16 A, contact-protected. Power input and output connector GST18i3 plug and GST18i3 socket. 2× modular couplings RJ45 to RJ45 Cat.6 shielded, 1:1 interconnected. Entry for data cables in the opposite end cap.</p>		<p>Silver anodised with mounting angles</p> <p>Silver anodised without mounting angles</p>	<p>1596 0000 5900</p> <p>1596 0000 3300</p>

Configure your individual EVOLine U-Dock using the EVOLine Modular System

See page 6-7 for instructions

Configurable Basic Housing EVOLine U-Dock

Aluminium housing



Silver anodised
End caps optionally with or
without mounting angles

9330 8510 0000

EVoline® Up



EVoline[®] Up

Thanks to its slim shape, the EVoline Up fits on any work surface, no matter how small, making access to electricity very convenient.

It organises the most important connections at the workplace and bundles them within easy reach on the desk. The surface is available as standard in black, white or brushed stainless steel. The vertical multiple socket can either be firmly screwed to the surface or quickly and securely attached to any work surface - even glass - using adhesive strips and removed without leaving any residue if required. This allows the electrification system to be used in the case of a Conversion can be easily reinstalled at a new location.

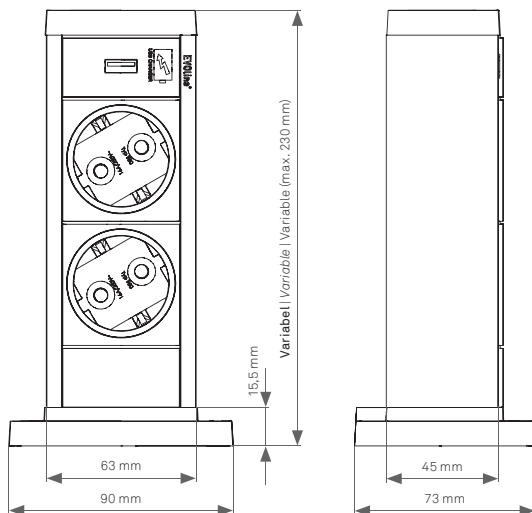

Housing	Aluminium, anodised or powder-coated
Stand	Plastic
Installation type	- On-Desk - Freestanding

Internationally approved
socket modules



Various powerful USB chargers
available

Stand can be bolted on request

Function and Design.



silver/black



black/black



white/black



white/white

Available colours

Double USB Charger



4 mounting holes for permanent mounting. Slide stops are included for mobile use.

Standard cable length 3.0 m. Other cables lengths and connectors on request possible.

A simple adhesive assembly with power strips is also suitable for easy fixation on the stand surface. The adhesive bond can be removed at any time without leaving any residue. The EVOLine Up can be affixed to another place, even onto glass. The Power Strips can be ordered directly from us.

Also vertical cable routing possible.

EVoline® Up

Description	Picture	Specifications	Order Number
EVoline Up Aluminium housing silver anodized 2 × VDE Sockets 0°, 16 A 1 × USB-Charger Type A, 5V / 1A 4 × SlideStops Fixed supply cable 3.0 m Angled plug Dimensions (W × H × D): 90 × 75 × 180 mm	 A vertical, rectangular power strip with a silver anodized aluminum housing and a black top and bottom. It features two VDE sockets, a USB-A port, and four slide stops.	Housing silver anodised black anodised white powder coated	 1593 9000 0900 1593 9000 2700 1593 9000 2900

Configure your individual EVoline Up using the EVoline Modular System

See page 6-7 for instructions

Configurable Basic Housing EVoline Up

Aluminium housing
4× Slide-Stops

Note: Max. configuration: 3 ½ modules



Housing

Silver anodised	9332 2690 0000
black anodised	9332 2680 0000
white powder coated	9332 2700 0000

EVOLine® Vertical

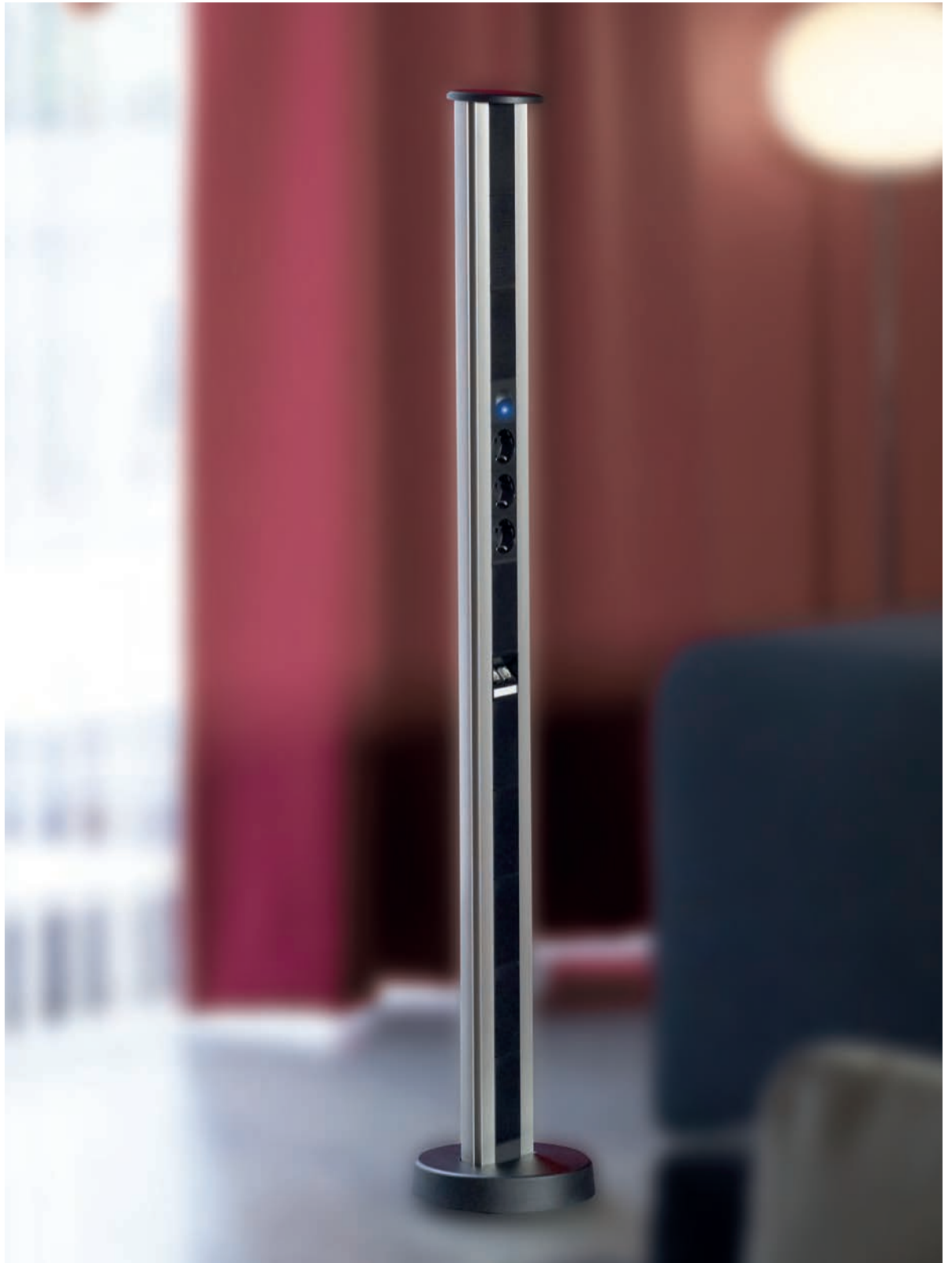

Stable. Free standing.

EVoline® Vertical

EVoline Vertical is a free standing solution for any room. Securely fixed to a solid cast iron base, the Vertical is upright, mobile, space saving and is the ideal solution for offices, hotels or retail areas.

The maximum height of 1.20 m makes it unnecessary to bend over to reach sockets: Power, data and multimedia modules are available at a convenient height. It can be positioned right aside a floor outlet.



Profile	Aluminium, anodised
Base	Solid cast iron
Installation	Free standing
Configurable	yes

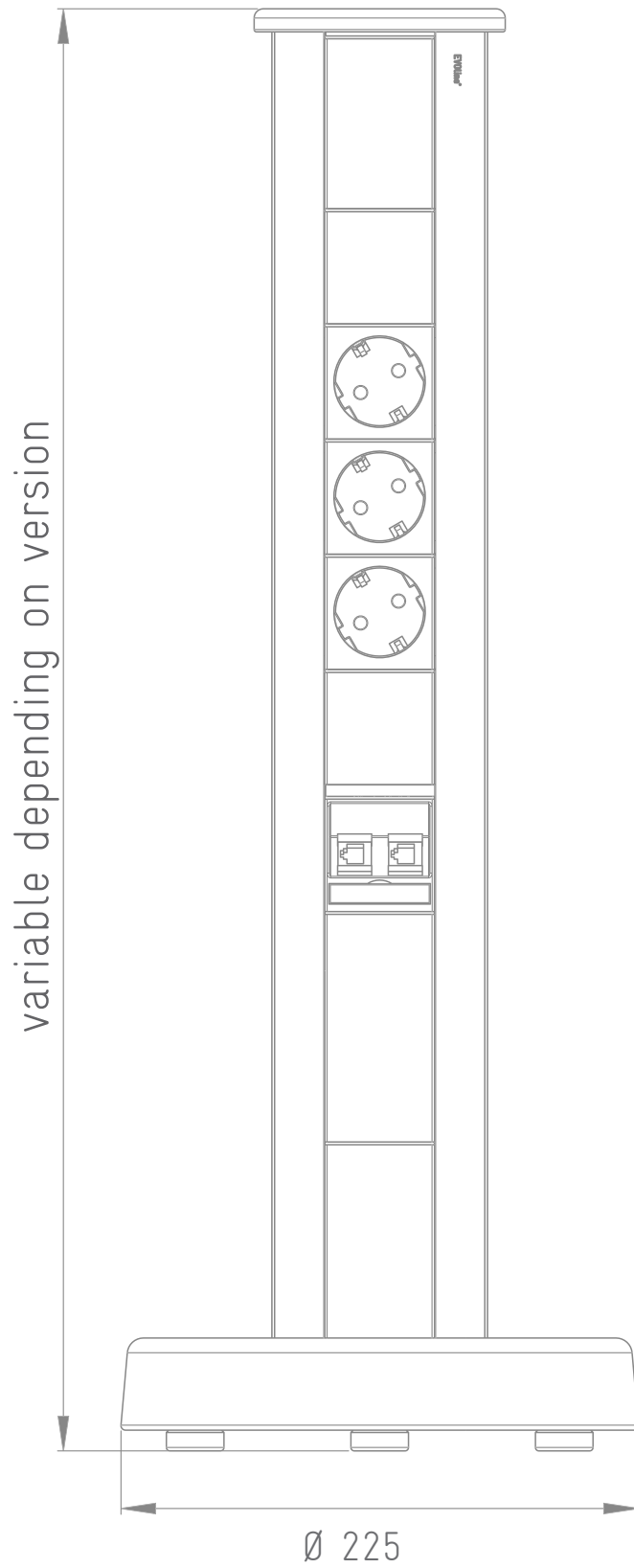

Dimensions in mm

EVoline® Vertical

Description	Picture	Specifications	Order Number
<p>EVoline Vertical Standard</p> <p>Aluminium housing, Cover made of aluminium, black powder-coated. Base made of solid cast iron, black powder-coated. 3× sockets, VDE-compliant, 60°, 16 A, contact-protected. Fixed supply cable, 3.0 m with angled plug. 2× data sockets RJ 45 CAT 6 shielded each 3.0 m cable and plug.</p>		Silver anodised	1593 4300 1100
		Black anodised	1593 4300 5000

Dimensions Base:
Diameter ø 24,5 cm
Height: 4 cm Profile
Height: 600 mm.

Configure your individual EVoline Vertical using the EVoline Modular System

See page 6-7 for instructions

Configurable Basic Housing EVoline Vertical

Aluminium housing, free standing, base made of solid cast iron, black powder-coated. Cover made of aluminium, black powder-coated.

Dimensions Base:
Diameter ø 24,5 cm
Height: 4 cm

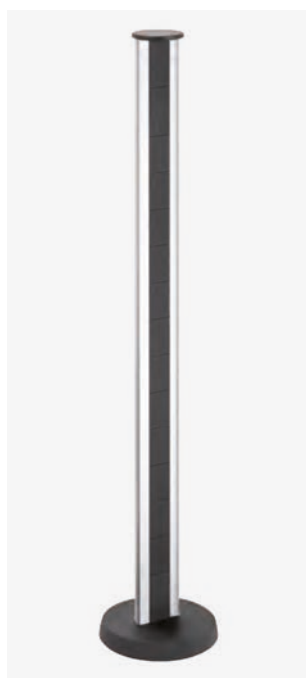

Silver anodised	9330 8560 0000
Black anodised	9330 8570 0000
Profile height 600 mm max. profile height 1200 mm	
Profile extension > 600 mm per 50 mm	9330 0130 0000

EVoline[®] Decentralised Electrical Distribution

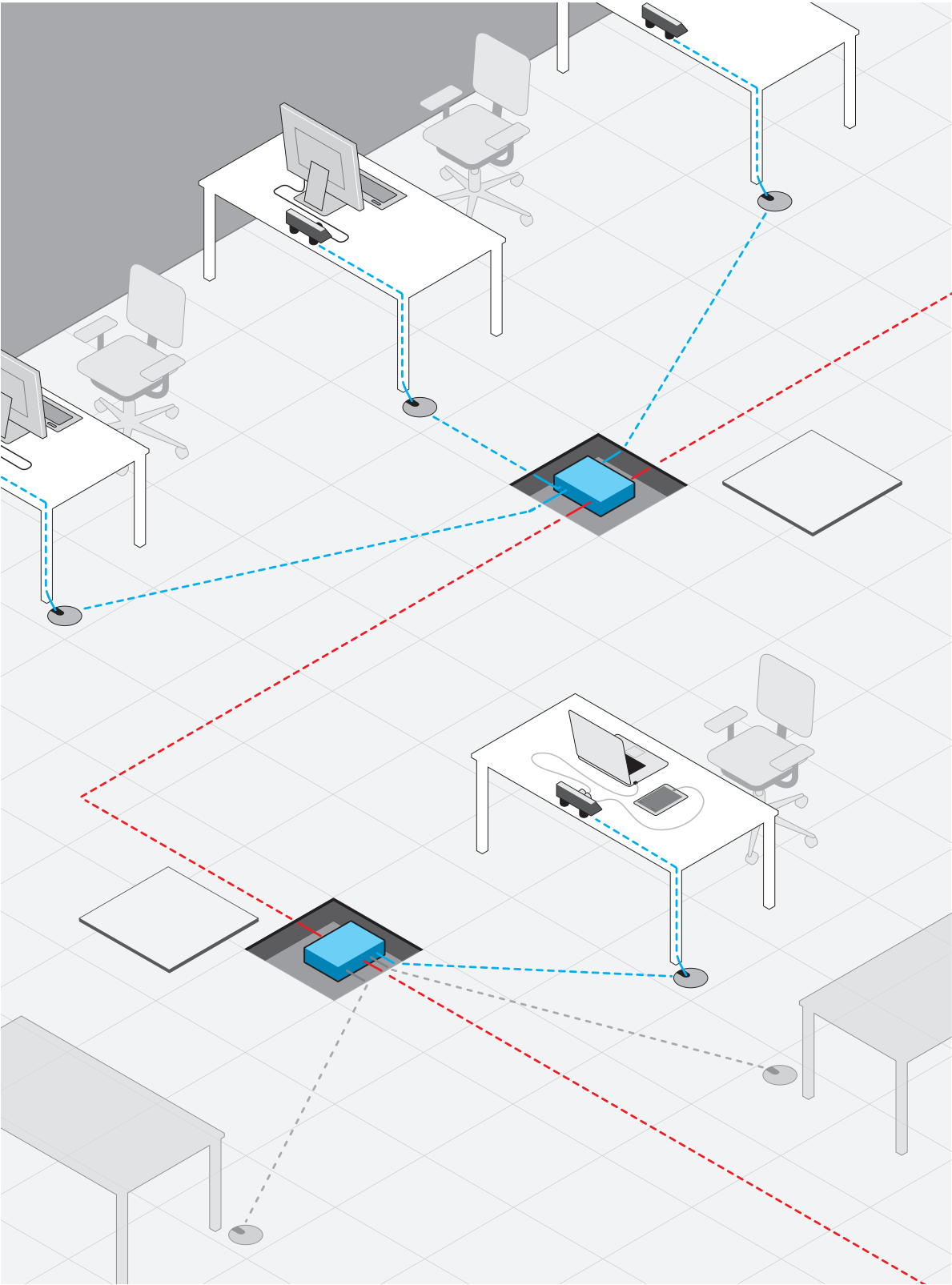

Long-term flexibility, low costs and high operational security.

EVoline[®] Decentralised Electrical Distribution

The modern work life becomes more and more flexible. Nowadays adaptable spaces along with mobile furniture and equipment within individually created work areas are standard in many offices already. A conventional approach usually reaches its limits because of the services infrastructure.

The essential importance of a flexible power supply is often underestimated during the planning stages. Long-term consequences can often result in cable chaos with potentially fatal safety defects, questionable auxiliary structures or expensive new cable supplies.

The perfect solution: Decentralised Electrical Distribution from Schulte Elektrotechnik.

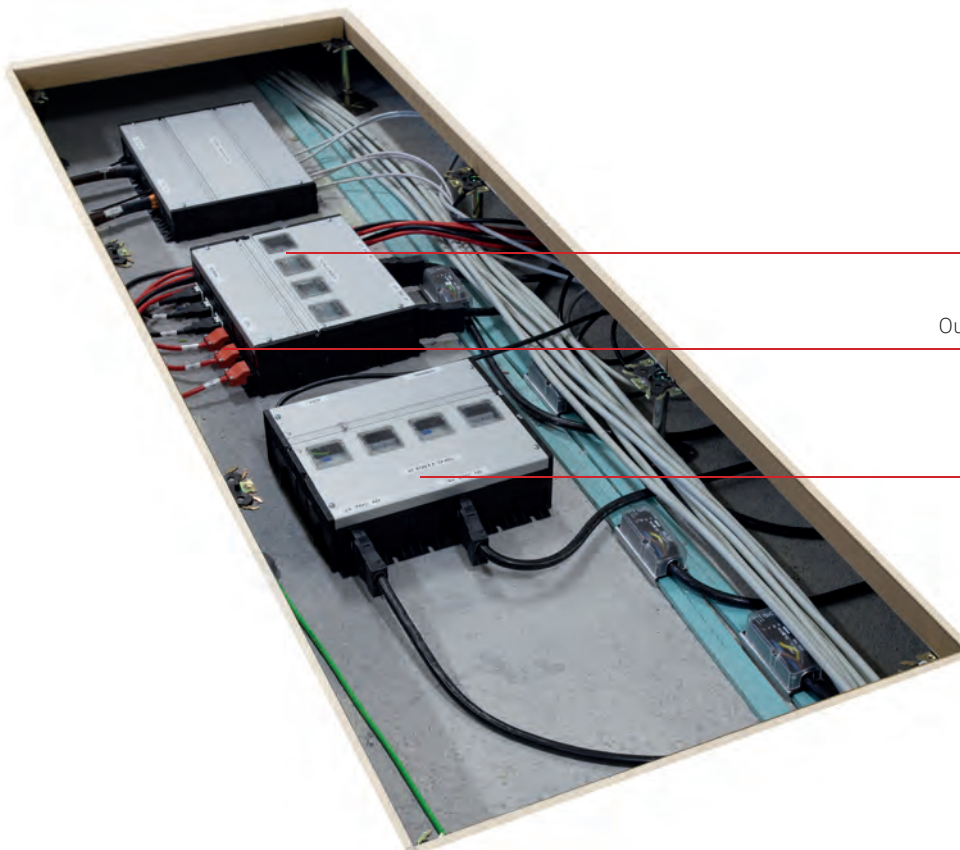

Consolidation Point Current circuit 1
with protection

Outputs to the e-Place devices, accessible

Consolidation Point Current circuit 2
with protection

Conventional Electrical Planning

- Increased space requirements for cables
- High fire loads
- High planning costs
- Expensive installation costs
- Labour intensive installation
- Big distribution boxes
- Mandatory 'Electrics Room'

Decentralised Electrical Distribution

- + Smaller 'Electrics Room'
- + Flexibility
- + Easy to change configurations
- + Simplicity
- + Compatible with EnOcean system
- + Safety
- + Aesthetics
- + Future proof
- + Faster installation

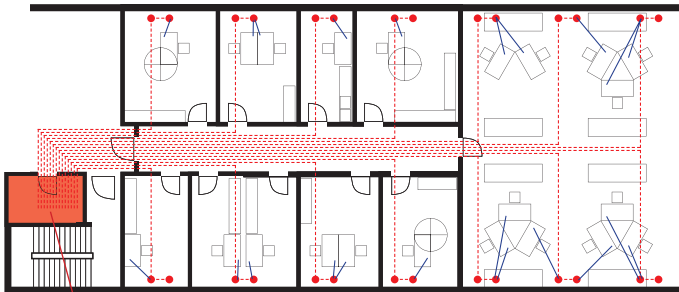

Big
Technical Room

In the office:
Conventional electrical planning

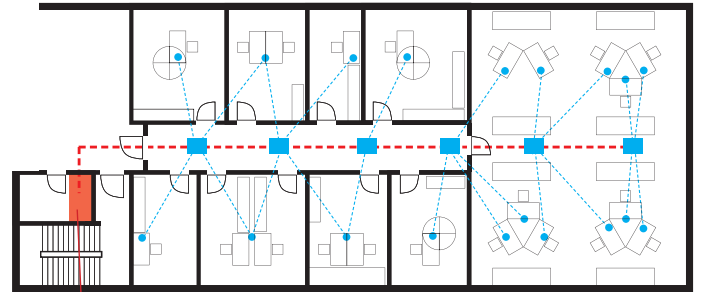

Small
switchboard

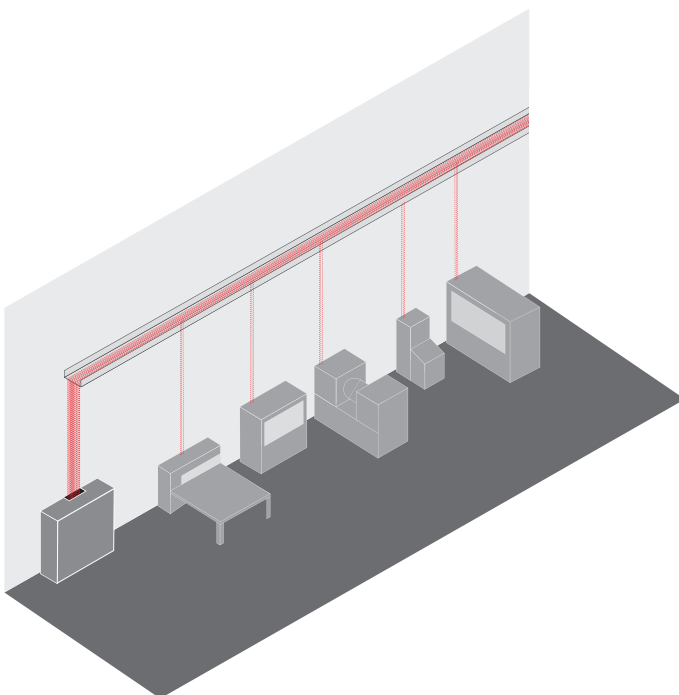

In the office:
Decentralised electrical distribution
with EVOLine Consolidation Points

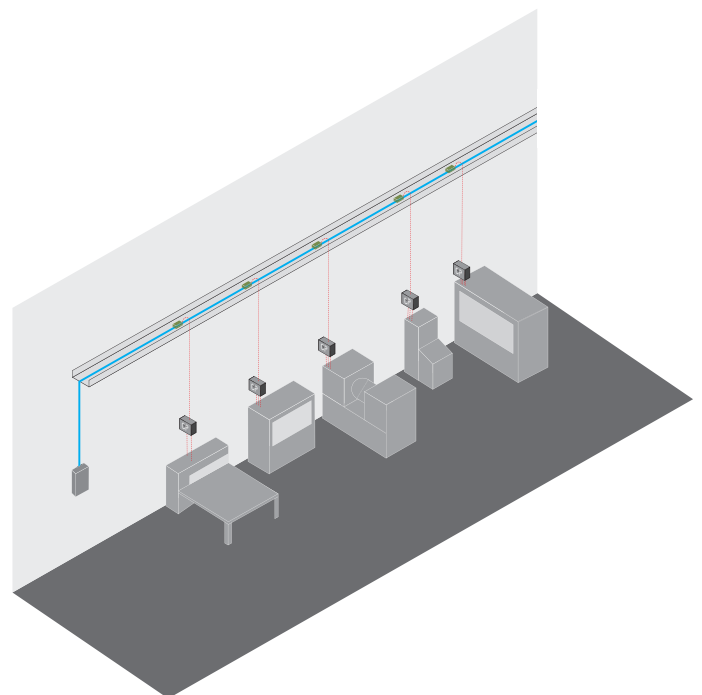

In the production:
Conventional electrical planning



In the production:
Decentralised electrical distribution
with EVOLine Consolidation Points

Description	Picture	Specifications	Order Number
<p>EVOLine Consolidation Point Power Mini</p> <p>For the power supply of workspaces and electrical devices; for usage inside double or cavity floors or suspended ceilings.</p> <p>Dimensions: 250mm × 250 mm × 90mm</p>		<p>Input side: 1× cable gland M25</p> <p>Built-in devices: 1× RCD Rated current: 40 A Rated residual current: 30 mA 3× MCB Rated current: 16 A Characteristic: B</p> <p>Output side: 3 × 3-pole socket (WAGO WINSTA) for the connection of electrical consumers</p>	1594 2000 2300
<p>EVOLine Consolidation Point Power Maxi</p> <p>For power supply of workspaces and electrical devices; for usage inside double or cavity floors or suspended ceilings.</p> <p>Dimensions: 300mm × 250 mm × 90mm</p>		<p>Input side: 1× cable gland M25</p> <p>Built-in devices: 1× RCD Rated current: 40 A Rated residual current: 30 mA 3× MCB Rated current: 16 A Characteristic: B</p> <p>Output side: 6× 3-pole socket and 1× 5-pole socket (WAGO WINSTA) for the connection of electrical consumers</p>	1594 2000 2400

EVOLine® Modules



Endless possibilities.

EVoline[®] Modules





EVoline systems can be configured to individual needs with a wide range of modules available - there is no general solution for the supply of e-connectivity.

Often just power sockets are the sufficient configuration: in a different environment international sockets plus USB Chargers may be the right choice. With telephones, EDP and multimedia connectors options become even more diverse.



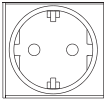
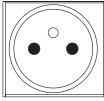
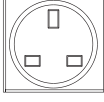
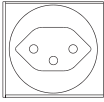
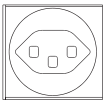

Whether a data or a HDMI connector, the individual application defines the requirements.

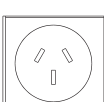
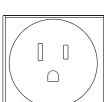

The chart below gives an overview about country specific socket versions. Deviations may occur.



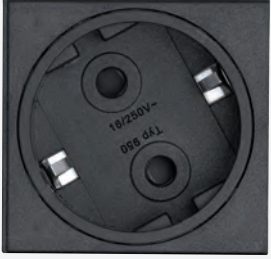

Socket VDE (CEE 7/3) 230 V, 16 A		Plug Type F, E+F, C	Algeria, Andorra, Armenia, Austria, Bosnia and Herzegovina, Bulgaria, Estonia, Finland, Georgia, Germany, Hungary, Iceland, Latvia, Lithuania, Luxembourg, Macedonia, Moldova, Montenegro, Netherlands, Norway, Portugal, Romania, Russia, Serbia, South Korea, Spain, Ukraine
Socket (CEE 7/5) 230 V, 16 A		Plug Type E, E+F, C	France, Belgium, Cameroon, Czech Republic, Mali, Morocco, Poland, Slovakia, Tunisia
Socket (BS 1363) 230 V, 3,15 A, 5 A or 13 A		Plug Type G	Great Britain, Bahrain, Cyprus, Hong Kong, Indonesia, Ireland, Kenya, Kuwait, Malaysia, Malta, Mauritius, Nigeria, Oman, Qatar, Saudi Arabia, Singapore, United Arab Emirates, Zimbabwe
Socket (SEV 1011) 230 V, 10 A, T13		Plug Type J, C	Switzerland, Liechtenstein
Socket (SEV 1011) 230 V, 16 A, T23		Plug Type J, C	Switzerland, Liechtenstein
Socket (DS 608842-D1) 230 V, 13 A		Plug Type K, C	Denmark, Greenland
Socket (DS 608842-D1) 230 V, 13 A, EDV		Plug Type K EDV	Denmark, Greenland
Socket (CEI 23-16-VII) 230 V, 16 A oder 10 A		Plug Type L, C	Italy, Chile, Cuba
Socket (AS 3112) 230 V, 10 A		Plug Type I	Australia, New Zealand, Papua New Guinea, several Pacific Islands
Socket (NEMA 5-15) 120 V, 15 A		Plug Type B	USA, Canada, Cuba, Ecuador, Jamaica, Japan, Mexico, Paraguay, Peru, Philippines, Taiwan, Venezuela, various Caribbean Islands

* Power modules are only available completely assembled in EVOLine products.





Description	Picture	Order Nr. & Specifications	<i>Dock / R-Dock</i> <i>Dock Square</i> <i>FlipTop</i> <i>Push</i> <i>FrameDock</i> <i>One</i> <i>Port</i> <i>Port Push</i> <i>U- & V-Dock</i> <i>Up</i>
Socket 0°, 16 A Contact-protected, VDE		9330 0090 0000 black	● ● ● ● ● ●
for plug type: F, C, E+F		9330 0200 0000 red	● ● ● ● ● ●
Installation dimensions: 50 x 50 mm		9330 5450 0000 white	● ● ● ● ● ●
		9330 5480 0000 light grey	● ● ● ● ● ●
Socket 0°, 16 A without Contact-protection, VDE		9330 6190 0000 black	● ● ● ● ● ●
for plug type: F, C, E+F		9330 6220 0000 red	● ● ● ● ● ●
Installation dimensions: 50 x 50 mmv			
Socket 0°, 16 A Contact-protected, VDE		9330 8130 0000 black socket, plastic frame lacquered in stainless steel optics (ALANOX®)	● ● ● ● ● ●
for plug type: F, C, E+F			
Installation dimensions: 50 x 50 mm			
Socket 60°, 16 A Contact-protected, VDE		9330 1050 0000 black	● ● ● ● ● ●
for plug type: F, C, E+F		9330 1430 0000 red	● ● ● ● ● ●
Installation dimensions: 50 x 50 mm		9330 5460 0000 white	● ● ● ● ● ●
		9330 5490 0000 light grey	● ● ● ● ● ●
Socket 60°, 16 A without Contact-protection, VDE		9330 6200 0000 black	● ● ● ● ● ●
for plug type: F, C, E+F		9330 6230 0000 red	● ● ● ● ● ●
Installation dimensions: 50 x 50 mm			





*Dock / R-Dock
 Dock Square
 FlipTop Push
 FrameDock
 One
 Port
 Port Push
 U- & V-Dock
 Up*

Description	Picture	Order Nr. & Specifications															
<p>Socket 90°, 16 A Contact-protected, VDE</p> <p>for plug type: F, C, E+F</p> <p>Installation dimensions: 50 x 50 mm</p>		<p>9330 1260 0000 black</p> <p>9330 1500 0000 red</p>	<table border="1"> <tr> <td>•</td><td>•</td><td>•</td><td>•</td><td>•</td> </tr> <tr> <td>•</td><td>•</td><td>•</td><td>•</td><td>•</td> </tr> </table>	•	•	•	•	•	•	•	•	•	•				
•	•	•	•	•													
•	•	•	•	•													
<p>Socket 90°, 16 A without Contact-protection, VDE</p> <p>for plug type: F, C, E+F</p> <p>Installation dimensions: 50 x 50 mm</p>		<p>9330 6210 0000 black</p> <p>9330 6240 0000 red</p>	<table border="1"> <tr> <td>•</td><td>•</td><td>•</td><td>•</td><td>•</td> </tr> <tr> <td>•</td><td>•</td><td>•</td><td>•</td><td>•</td> </tr> </table>	•	•	•	•	•	•	•	•	•	•				
•	•	•	•	•													
•	•	•	•	•													
<p>Socket 0°, 16 A Contact-protected, FR/BE/PL</p> <p>France, Belgium, Poland for plug type: E, C, E+F</p> <p>Installation dimensions: 50 x 50 mm,</p>		<p>9330 0250 0000 black</p> <p>9331 1810 0000 white</p>	<table border="1"> <tr> <td>•</td><td>•</td><td>•</td><td>•</td><td>•</td><td>•</td> </tr> <tr> <td>•</td><td>•</td><td>•</td><td>•</td><td>•</td><td>•</td> </tr> </table>	•	•	•	•	•	•	•	•	•	•	•	•		
•	•	•	•	•	•												
•	•	•	•	•	•												
<p>Socket 60°, 16 A Contact-protected, FR/BE/PL</p> <p>France, Belgium, Poland for plug type: E, C, E+F</p> <p>Installation dimensions: 50 x 50 mm,</p>		<p>9330 1060 0000 black</p> <p>9332 1650 0000 white</p>	<table border="1"> <tr> <td>•</td><td>•</td><td>•</td><td>•</td><td>•</td><td>•</td><td>•</td> </tr> <tr> <td>•</td><td>•</td><td>•</td><td>•</td><td>•</td><td>•</td><td>•</td> </tr> </table>	•	•	•	•	•	•	•	•	•	•	•	•	•	•
•	•	•	•	•	•	•											
•	•	•	•	•	•	•											



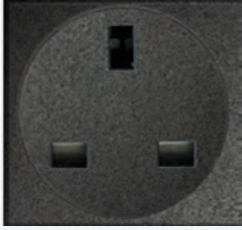

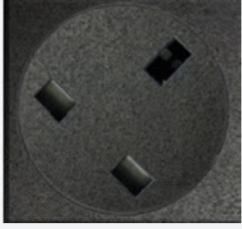
Description	Picture	Order Nr. & Specifications	<i>/ Dock / R-Dock</i> <i>/ Dock Square</i> <i>/ FlipTopPush</i> <i>/ FrameDock</i> <i>/ One</i> <i>/ Port</i> <i>/ PortPush</i> <i>/ U- & V-Dock</i> <i>/ Up</i>
Socket 0°, 10 A without Contact-protection, CH		9330 1100 0000 black	● ● ● ● ● ●
Switzerland for plug type: J, C		9330 1480 0000 red	● ● ● ● ● ●
Installation dimensions: 50 x 50 mm		9331 9920 0000 white	● ● ● ● ● ●
Socket 0°, 16 A without Contact-protection, CH		9330 1010 0000 black	● ● ● ● ● ●
Switzerland for plug type: J, C		9330 1710 0000 red	● ● ● ● ● ●
Installation dimensions: 50 x 50 mm		9332 1210 0000 white	● ● ● ● ● ●
Socket 60°, 10 A without Contact-protection, CH		9330 1110 0000 black	● ● ● ● ● ●
Switzerland for plug type: J, C		9330 1490 0000 red	● ● ● ● ● ●
Installation dimensions: 50 x 50 mm			
Socket 60°, 16 A without Contact-protection, CH		9330 1070 0000 black	● ● ● ● ● ●
Switzerland for plug type: J, C		9330 1450 0000 red	● ● ● ● ● ●
Installation dimensions: 50 x 50 mm			
Socket 270°, 10 A without Contact-protection, CH		9330 1280 0000 black	● ● ● ● ● ●
Switzerland for plug type: J, C		9330 1550 0000 red	● ● ● ● ● ●
Installation dimensions: 50 x 50 mm			



Dock / R-Dock
 Dock Square
 FlipTop Push
 FrameDock
 One
 Port
 Port Push
 U- & V-Dock
 Up

Description	Picture	Order Nr. & Specifications								
<p>Socket 270°, 16 A without Contact-protection, CH</p> <p>Switzerland for plug type: J, C</p> <p>Installation dimensions: 50 x 50 mm</p>		<p>9330 1290 0000 black</p> <p>9330 1520 0000 red</p>	•	•	•	•	•	•	•	
<p>Socket 0°, 13 A Contact-protected, DK</p> <p>Denmark, Standard for plug type: K, C</p> <p>Installation dimensions: 50 x 50 mm</p>		<p>9330 1020 0000 black</p> <p>9332 1230 0000 white</p>	•	•	•	•	•	•	•	
<p>Socket 0°, 13 A Contact-protected, DK</p> <p>Denmark, EDV-coded for plug type: K</p> <p>Installation dimensions: 50 x 50 mm</p>		<p>9330 1030 0000 black</p> <p>9330 1730 0000 red</p>	•	•	•	•	•	•	•	
<p>Socket 60°, 13 A Contact-protected, DK</p> <p>Denmark, Standard for plug type: K, C</p> <p>Installation dimensions: 50 x 50 mm</p>		<p>9330 1080 0000 black</p>	•	•	•	•	•	•	•	
<p>Socket 240°, 13 A Contact-protected, DK</p> <p>Denmark, Standard for plug type: K, C</p> <p>Installation dimensions: 50 x 50 mm</p>		<p>9330 7190 0000 black</p>	•	•	•	•	•	•	•	

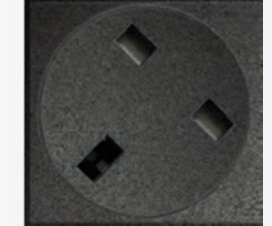
Description	Picture	Order Nr. & Specifications	<i>/ Dock / R-Dock</i> <i>/ Dock Square</i> <i>/ FlipTop</i> <i>/ Push</i> <i>/ FrameDock</i> <i>/ One</i> <i>/ Port</i> <i>/ PortPush</i> <i>/ U- & V-Dock</i> <i>/ Up</i>
Socket 0°, 13 A Contact-protected, GB		9332 0530 0000 black	● ● ● ● ● ● ● ● ●
Great Britain without fuse, for plug type: G		9332 2220 0000 white	● ● ● ● ● ● ● ● ●
Installation dimensions: 50 x 50 mm			
Socket 0° Contact-protected, GB		9332 0560 0000 black; 3,15 A	● ● ● ● ● ● ● ● ●
Great Britain with integrated fuse for plug type: G		9332 2250 0000 white; 3,15 A	● ● ● ● ● ● ● ● ●
Installation dimensions: 50 x 50 mm		9332 0590 0000 black; 5 A	● ● ● ● ● ● ● ● ●
		9332 2280 0000 white; 5 A	● ● ● ● ● ● ● ● ●
Socket 45°, 13 A Contact-protected, GB		9332 0540 0000 black	● ● ● ● ● ● ● ● ●
Great Britain without fuse, for plug type: G		9332 2230 0000 white	● ● ● ● ● ● ● ● ●
Installation dimensions: 50 x 50 mm			
Socket 45° Contact-protected, GB		9332 0570 0000 black; 3,15 A	● ● ● ● ● ● ● ● ●
Great Britain with integrated fuse for plug type: G		9332 2260 0000 white; 3,15 A	● ● ● ● ● ● ● ● ●
Installation dimensions: 50 x 50 mm		9332 0600 0000 black; 5 A	● ● ● ● ● ● ● ● ●
		9332 2290 0000 white; 5 A	● ● ● ● ● ● ● ● ●

Dock / R-Dock
Dock Square
FlipTop Push
FrameDock
One
Port
Port Push
U- & V-Dock
Up

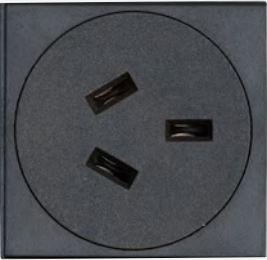
Description	Picture	Order Nr. & Specifications	
<p>Socket 90°, 13 A Contact-protected, GB</p> <p>Great Britain without fuse, for plug type: G</p> <p>Installation dimensions: 75 x 50 mm incl. spacer plate: 25 mm</p>		<p>9330 4430 9000 black</p>	<div style="display: flex; justify-content: space-between;"> <div style="width: 15%;"></div> <div style="width: 15%; text-align: center;">●</div> <div style="width: 15%;"></div> <div style="width: 15%; text-align: center;">● ●</div> <div style="width: 15%; text-align: center;">●</div> </div>
<p>Socket 90° Contact-protected, GB</p> <p>Great Britain with integrated fuse for plug type: G</p> <p>Installation dimensions: 75 x 50 mm incl. spacer plate: 25 mm</p>		<p>9330 4450 9000 black; 3,15 A</p> <p>9330 4470 9000 black; 5 A</p>	<div style="display: flex; justify-content: space-between;"> <div style="width: 15%;"></div> <div style="width: 15%; text-align: center;">●</div> <div style="width: 15%;"></div> <div style="width: 15%; text-align: center;">● ●</div> <div style="width: 15%; text-align: center;">●</div> </div> <div style="display: flex; justify-content: space-between; margin-top: 10px;"> <div style="width: 15%;"></div> <div style="width: 15%; text-align: center;">●</div> <div style="width: 15%;"></div> <div style="width: 15%; text-align: center;">● ●</div> <div style="width: 15%; text-align: center;">●</div> </div>
<p>Socket 225°, 13 A Contact-protected, GB</p> <p>Great Britain without fuse, for plug type: G</p> <p>Installation dimensions: 50 x 50 mm</p>		<p>9332 2750 0000 black</p>	<div style="display: flex; justify-content: space-between;"> <div style="width: 15%;"></div> <div style="width: 15%; text-align: center;">●</div> <div style="width: 15%;"></div> <div style="width: 15%;"></div> <div style="width: 15%; text-align: center;">●</div> </div>
<p>Socket 225° Contact-protected, GB</p> <p>Great Britain with integrated fuse for plug type: G</p> <p>Installation dimensions: 50 x 50 mm</p>		<p>9332 2760 0000 black; 3,15 A</p> <p>9332 2770 0000 black; 5 A</p>	<div style="display: flex; justify-content: space-between;"> <div style="width: 15%;"></div> <div style="width: 15%; text-align: center;">●</div> <div style="width: 15%;"></div> <div style="width: 15%;"></div> <div style="width: 15%; text-align: center;">●</div> </div> <div style="display: flex; justify-content: space-between; margin-top: 10px;"> <div style="width: 15%;"></div> <div style="width: 15%; text-align: center;">●</div> <div style="width: 15%;"></div> <div style="width: 15%;"></div> <div style="width: 15%; text-align: center;">●</div> </div>

Description	Picture	Order Nr. & Specifications	<i>Dock / R-Dock</i> <i>Dock Square</i> <i>FlipTop Push</i> <i>FrameDock</i> <i>One</i> <i>Port</i> <i>Port Push</i> <i>U- & V-Dock</i> <i>Up</i>
Socket 0°, 10 A without Contact-protection, AUS		9330 5240 0000 black	● ● ● ● ● ●
Australia for plug type: I		9330 5270 0000 red	● ● ● ● ● ●
Installation dimensions: 50 x 50 mm			
Socket 270°, 10 A without Contact-protection, AUS		9330 5890 0000 black	● ● ● ● ● ●
Australia for plug type: I			
Installation dimensions: 50 x 50 mm			
Socket 0°, 10 A Angled Outlet without Contact-protection, AUS		9330 4010 0000 black	● ● ● ● ● ●
Australia for plug type: I, Not suitable for angled plugs.		9330 4400 0000 red	● ● ● ● ● ●
Installation dimensions: 75 x 50 mm			

*Dock / R-Dock
 Dock Square
 FlipTop Push
 FrameDock
 One
 Port
 Port Push
 U- & V-Dock
 Up*

Description

Picture

Order Nr. & Specifications

**Socket 0°, 15 A
without Contact-protection
USA/CAN**

USA, Canada
for plug type: B (NEMA, 5-15)

Installation dimensions: 50 x 50 mm



9330 5360 6600
black



**Socket 60°, 15 A
without Contact-protection
USA/CAN**

USA, Canada
for plug type: B

Installation dimensions: 50 x 50 mm



9330 5370 6600
black



**Socket 0°, 15 A
with Contact-protection,
USA/ CAN**

USA, Canada
for plug type: B

Installation dimensions: 50 x 50 mm



9332 3640 6600
black



**Socket 60°, 15 A
with Contact-protection,
USA/ CAN**

USA, Canada
for plug type: B

Installation dimensions: 50 x 50 mm



9332 3650 6600
black



**Socket 0°, 15 A Angled Outlet
with Contact-protection and hin-
ged lid, USA/CAN**

USA, Canada
for plug type: B
Not suitable for angled plugs.





Installation dimensions: 75 x 50 mm







9332 3630 6600
black















○ No UL-listed product. Feasibility to be enquired individually.
 Technical changes and printing errors reserved. | Similar pictures.



Description	Picture	Order Nr. & Specifications	<i>/ Dock / R-Dock</i> <i>/ Dock Square</i> <i>/ FlipTopPush</i> <i>/ FrameDock</i> <i>/ One</i> <i>/ Port</i> <i>/ PortPush</i> <i>/ U- & V-Dock</i> <i>/ Up</i>
<p>Socket 0°, 10 A / 16 A Contact-protected, IT</p> <p>Italy for plug type: L, C</p> <p>Installation dimensions: 25 x 50 mm</p>		9331 3180 0000	● ● ● ● ● ● ● ●
<p>Connector 16 A Wieland GST 18i3</p> <p>Socket GST 18i3 Snap-In for current output</p> <p>Installation dimensions: 25 x 50 mm</p>		9330 8990 0000 black	● ● ● ● ● ● ● ●
<p>Connector 16 A WAGO WINSTA MIDI</p> <p>Socket WAGO WINSTA Snap-In for current output</p> <p>Installation dimensions: 25 x 50 mm</p>		9330 8970 0000 black	● ● ● ● ● ● ● ●
<p>USB Charger</p> <p>USB Type A Charger, charging function only. Supply voltage: 100-240 VAC</p> <p>Installation dimensions: 25 x 50 mm</p>		9331 5580 0000 5 V / 1 A, black 9331 7040 0000 5 V / 1 A, white 9332 1330 0000 5 V / 2.1 A, black 9332 1320 0000 5 V / 2.1 A, white	● ●
<p>Double USB-Charger</p> <p>2x USB Type A Charger, charging function only. Supply voltage: 100-240 VAC</p> <p>Installation dimensions: 25 x 50 mm</p>		9332 2960 0000 5 V / 2.1 A max., black 9332 2970 0000 5 V / 2.1 A max., white	● ● ● ● ● ● ● ● ● ● ● ● ● ● ● ●

Description	Picture	Order Nr. & Specifications	Dock / R-Dock Dock Square FlipTop Push FrameDock One Port Port Push U- & V-Dock Up
<p>Power Supply Module with cable and EVOLine PlugFix</p> <p>Type E+F i.e. Germany 16 A, 3 x 1.5 mm² Plug with extra low profile and movable plug face.</p>		<p>9331 0890 0000 Cable length 3 m, black</p> <p>Cable extension per meter</p>	<p>• • • • • • • • •</p>
<p>Power Supply Module with cable and angled plug</p> <p>Type E+F i.e. Germany, France, Belgium, Poland 16 A, 3 x 1.5 mm²</p>		<p>9330 2020 0000 Cable length 3 m, black</p> <p>9332 2670 0000 Cable length 3 m, white</p> <p>Cable extension per meter</p>	<p>• • • • • • • • •</p> <p>• • • • • • • • •</p>
<p>Power Supply Module with cable and plug</p> <p>Type J 3 x 1,5 mm² i.e. Switzerland</p>		<p>9330 2030 0000 10 A, Cable length 3 m, black</p> <p>9330 2040 0000 16 A, Cable length 3 m, black</p> <p>Cable extension per meter</p>	<p>• • • • • • • • •</p> <p>• • • • • • • • •</p>
<p>Power Supply Module with Cable and Overload Circuit Breaker</p> <p>Plug type J (T12) Power Supply Module with resettable overload switch 10 A 3 x 1,5 mm²</p>		<p>9332 1090 0000 Cable length 3 m, black mounted to product</p> <p>Cable extension per meter</p>	<p>• • • • • • • • •</p>
<p>Power Supply Module with cable and angled plug</p> <p>Type G, i.e. Great Britain 13 A, 3 x 1,5 mm²</p>		<p>9330 2070 0000 Cable length 3 m, black</p> <p>Cable extension per meter</p>	<p>• • • • • • • • •</p> <p>• • • • • • • • •</p>

Description	Picture	Order Nr. & Specifications	/ Dock / R-Dock / Dock Square / FlipTop Push / FrameDock / One / Port / Port Push / U- & V-Dock / Up /
Power Supply Module with cable and angled plug Type K 13 A, 3 x 1.5 mm ² Denmark. Standard		9330 2050 0000 Cable length 3 m, black 9330 2060 0000 Plug, not angled, EDP-coded, Cable length 3 m black Cable extension per meter	● ●
Power Supply Module with cable and Plug Plug Type L i.e. Italy 16 A, 3 x 1.5 mm ²		9330 2080 0000 Cable length 3 m, black Cable extension per meter	● ●
Power Supply Module with cable and Plug Type B 115 V. 15 A, AWG 14 i.e. USA, Canada (UL/CSA)		9330 9160 6600 Cable length 3 m, black Cable extension on request	● ○ ○ ● ○ ● ○ ● ○ ● ○ ○ ● ○ ● ○ ● ○ ● ○ ○ ● ○ ● ○ ● ○ ● ○ ○ ● ○ ● ○ ● ○ ● ○ ○ ● ○ ● ○ ● ○
Power Supply Module with cable and Plug Type B 115 V. 15 A, AWG 14 i.e. Australia		9330 9130 0000 Cable length 3 m, black Cable extension on request	● ●
Power Supply Module with cable and ferrules 16 A, 3 x 1,5 mm ²		9330 9510 0000 Cable length 3 m, black Cable extension per meter	● ●

Dock / R-Dock
 Dock Square
 FlipTop Push
 FrameDock
 One
 Port
 Port Push
 U- & V-Dock
 Up

Description	Picture	Order Nr. & Specifications											
Power Supply Module with cable and connector 16 A, 3 × 1,5 mm ² Cable length 3 m Colour: black		9330 8420 0000 Wieland GST18 plug without lock	•	•	•	•	•	•	•	•	•	•	•
		9331 2490 0000 Wieland GST18 plug with lock	•	•	•	•	•	•	•	•	•	•	•
		9330 8440 0000 WAGO WINSTA MIDI plug without lock	•	•	•	•	•	•	•	•	•	•	•
		9332 4240 0000 Neutrik powerCON plug with lock	•	•	•	•	•	•	•	•	•	•	•
		Cable extension per meter											
Power Output Module with cable and connector 16 A, 3 × 1,5 mm ² Cable length 3 m Colour: black		9330 5810 0000 GST18i3 socket without lock	•	•	•	•		•	•	•			
		9331 2500 0000 GST18i3 socket with lock	•	•	•	•		•	•	•			
		9330 5830 0000 WAGO WINSTA MIDI socket without lock	•	•	•	•		•	•	•			
		9332 4250 0000 Neutrik powerCON socket with lock	•	•	•	•		•	•	•			
		Cable extension per meter											
Connector 3-pole Plug Installed in the end cap Colour: black		9330 2680 0000 Plug GST 18i3	•	•		•					•		
		9330 2660 0000 Plug WAGO WINSTA MIDI	•	•		•					•		
Connector 3 pole Socket Snap-In, installed in the end cap Colour: black		9330 8960 0000 Socket GST 18i3	•	•		•					•		
		9330 8940 0000 Socket WAGO WINSTA MIDI	•	•		•					•		

Description	Picture	Order Nr. & Specifications	<i>Dock / R-Dock</i> <i>Dock Square</i> <i>FlipTop Push</i> <i>FrameDock</i> <i>One</i> <i>Port</i> <i>Port Push</i> <i>U- & V-Dock</i> <i>Up</i>																				
<p>RJ45 Data Connector Reichle & De-Massari</p> <p>with Cable and Plug / Socket</p> <p>Installation Dimensions: 25 x 50 mm</p>		<p>9331 2150 0000 RJ45 CAT6 shielded 0.2 m Cable, Socket</p> <p>9330 8270 0000 RJ45 CAT6 unshielded 3 m Cable, Plug</p> <p>9330 7860 0000 RJ45 CAT6 shielded 3 m Cable, Plug</p> <p>9331 0020 0000 RJ45 CAT6A shielded 3 m Cable, Plug</p>	<table border="1"> <tr> <td>●</td> <td>●</td> <td>●</td> <td>●</td> <td></td> </tr> <tr> <td>●</td> <td>●</td> <td>●</td> <td>●</td> <td></td> </tr> <tr> <td>●</td> <td>●</td> <td>●</td> <td>●</td> <td></td> </tr> <tr> <td>●</td> <td>●</td> <td>●</td> <td>●</td> <td></td> </tr> </table>	●	●	●	●		●	●	●	●		●	●	●	●		●	●	●	●	
●	●	●	●																				
●	●	●	●																				
●	●	●	●																				
●	●	●	●																				
<p>RJ45 Data Connector Reichle & De-Massari</p> <p>Angled Outlet with labeling field with Cable and Plug</p> <p>Installation Dimensions: 50 x 50 mm</p>		<p>9331 8200 0000 RJ45 CAT6 shielded 0.2 m Cable, Socket (RJ45)</p> <p>9331 0010 0000 RJ45 CAT6 unshielded 3m Cable, Plug</p> <p>9330 6140 0000 RJ45 CAT6 shielded 3 m Cable Plug</p> <p>9331 0030 0000 RJ45 CAT6A shielded 3 m Cable Plug</p>	<table border="1"> <tr> <td></td> <td></td> <td></td> <td>●</td> <td>●</td> </tr> <tr> <td></td> <td></td> <td></td> <td>●</td> <td>●</td> </tr> <tr> <td></td> <td></td> <td></td> <td>●</td> <td>●</td> </tr> <tr> <td></td> <td></td> <td></td> <td>●</td> <td>●</td> </tr> </table>				●	●				●	●				●	●				●	●
			●	●																			
			●	●																			
			●	●																			
			●	●																			
<p>2x RJ45 Data Connector Reichle & De-Massari</p> <p>Angled Outlet with labeling field with Cable and Plug / Socket</p> <p>Installation Dimensions: 50 x 50 mm</p>		<p>9331 2590 0000 RJ45 CAT6 shielded 0.2 m Cable, Socket (RJ45)</p> <p>9330 4340 0000 RJ45 CAT6 unshielded 3m Cable, Plug</p> <p>9330 1230 0000 RJ45 CAT6 shielded 3 m Cable, Plug</p> <p>9331 0040 0000 RJ45 CAT6A shielded 3 m Cable, Plug</p>	<table border="1"> <tr> <td></td> <td></td> <td></td> <td>●</td> <td>●</td> </tr> <tr> <td></td> <td></td> <td></td> <td>●</td> <td>●</td> </tr> <tr> <td></td> <td></td> <td></td> <td>●</td> <td>●</td> </tr> <tr> <td></td> <td></td> <td></td> <td>●</td> <td>●</td> </tr> </table>				●	●				●	●				●	●				●	●
			●	●																			
			●	●																			
			●	●																			
			●	●																			

Dock / R-Dock
 Dock Square
 FlipTop Push
 FrameDock
 One Port
 Port Push
 U- & V-Dock
 Up

Description

Picture

Order Nr. & Specifications

**RJ45 Modular Adaptor
 ELBRO**

Modular Adaptor , 1:1 intercon-
 nected

Installation Dimensions:
 25 x 50 mm



9330 6550 0000
 RJ45 CAT6 unshielded

9330 8410 0000
 (RJ45) CAT6 shielded

9331 4080 0000
 (RJ45) CAT6A shielded

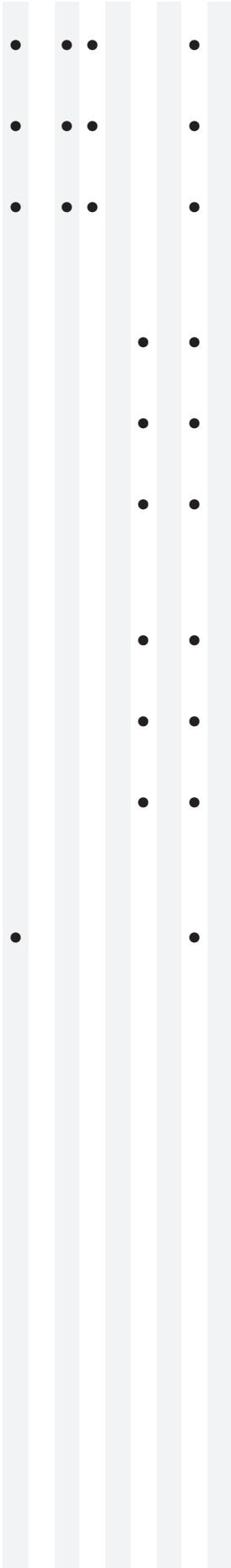

**RJ45 Modular Adaptor
 ELBRO**

Angled Outlet
 with labeling field.
 Modular Adaptor, 1:1 interconnected

Installation Dimensions:
 50 x 50 mm



9330 6560 0000
 (RJ45) CAT6 unshielded

9330 5880 0000
 (RJ45) CAT6 shielded

9331 4090 0000
 (RJ45) CAT6A shielded

**2x RJ45 Modular Adaptor
 ELBRO**

Angled Outlet
 with Labeling Field
 Modular Adaptor, 1:1 interconnected

Installation Dimensions:
 50 x 50 mm



9330 6570 0000
 (RJ45) CAT6 unshielded

9330 3920 0000
 (RJ45) CAT6 shielded

9331 4100 0000
 (RJ45) CAT6A shielded

**2x RJ45 Modular Adaptor
 ELBRO**





Modular Adaptor, 1:1 interconnected
 Angled: 90°





Installation Dimensions:
 25 x 50 mm





9331 4870 0000
 (RJ45) CAT6 shielded











Description	Picture	Order Nr. & Specifications	<i> Dock / R-Dock Dock Square FlipTop Push FrameDock One Port Port Push U- & V-Dock Up </i>
<p>VGA-Connector</p> <p>15 pole HDD socket with screw terminals, Installation dimensions: 25 x 50 mm</p>		<p>9330 0810 0000 with 3 m cable and plug</p>	<div style="display: flex; justify-content: space-around;"> <div style="width: 20px; height: 100%; background-color: #ccc; position: relative;"> ● </div> <div style="width: 20px; height: 100%; background-color: #ccc; position: relative;"> ● </div> <div style="width: 20px; height: 100%; background-color: #ccc; position: relative;"> ● </div> <div style="width: 20px; height: 100%; background-color: #ccc; position: relative;"> ● </div> <div style="width: 20px; height: 100%; background-color: #ccc; position: relative;"> ● </div> </div>
<p>VGA-Connector</p> <p>Angled outlet with labeling field 15 pole HDD socket with screw terminals, Installation dimensions: 50 x 50 mm</p>		<p>9330 2370 0000 with 3 m cable and plug</p>	<div style="display: flex; justify-content: space-around;"> <div style="width: 20px; height: 100%; background-color: #ccc; position: relative;"> ● </div> <div style="width: 20px; height: 100%; background-color: #ccc; position: relative;"> ● </div> <div style="width: 20px; height: 100%; background-color: #ccc; position: relative;"> ● </div> <div style="width: 20px; height: 100%; background-color: #ccc; position: relative;"> ● </div> <div style="width: 20px; height: 100%; background-color: #ccc; position: relative;"> ● </div> </div>
<p>VGA- and Audio Connector</p> <p>1x VGA Connector, 15 pole HDD socket with screw terminals, 1x Stereo Jack socket 3.5 mm Installation dimensions: 25 x 50 mm</p>		<p>9330 7920 0000 with 3 m cables and plugs</p>	<div style="display: flex; justify-content: space-around;"> <div style="width: 20px; height: 100%; background-color: #ccc; position: relative;"> ● </div> <div style="width: 20px; height: 100%; background-color: #ccc; position: relative;"> ● </div> <div style="width: 20px; height: 100%; background-color: #ccc; position: relative;"> ● </div> <div style="width: 20px; height: 100%; background-color: #ccc; position: relative;"> ● </div> <div style="width: 20px; height: 100%; background-color: #ccc; position: relative;"> ● </div> </div>
<p>VGA and Audio Connector</p> <p>Angled outlet with labeling field 1x VGA Connector, 15 pole HDD socket, with screw terminals. 1x Stereo Jack socket 3.5mm Installation dimensions: 50 x 50 mm</p>		<p>9331 5370 0000 with 3 m cables and plugs</p>	<div style="display: flex; justify-content: space-around;"> <div style="width: 20px; height: 100%; background-color: #ccc; position: relative;"> ● </div> <div style="width: 20px; height: 100%; background-color: #ccc; position: relative;"> ● </div> <div style="width: 20px; height: 100%; background-color: #ccc; position: relative;"> ● </div> <div style="width: 20px; height: 100%; background-color: #ccc; position: relative;"> ● </div> <div style="width: 20px; height: 100%; background-color: #ccc; position: relative;"> ● </div> </div>



Description	Picture	Order Nr. & Specifications	Dock / R-Dock Dock Square FlipTop Square FlipTop Push FrameDock One Port Port Push U- & V-Dock Up												
<p>Audio Connector 3.5mm</p> <p>1 x Stereo Jack socket 3.5 mm Installation dimensions: 25 x 50 mm</p>		<p>9330 0910 0000 with 3 m cable and plug</p>	<table border="1"> <tr> <td>•</td> <td>•</td> <td>•</td> <td>•</td> <td></td> <td></td> </tr> </table>	•	•	•	•								
•	•	•	•												
<p>Audio Connector 3.5mm</p> <p>Angled outlet with labeling field. 1 x Stereo Jack socket 3.5 mm Installation dimensions: 50 x 50 mm</p>		<p>9330 2460 0000 with 3 m cable and plug</p>	<table border="1"> <tr> <td>•</td> <td></td> <td></td> <td>•</td> <td>•</td> <td></td> </tr> </table>	•			•	•							
•			•	•											
<p>DVI-I Connector</p> <p>Dual Link. 24+5 pole. for digital and analogue signals Installation dimensions: 25 x 50 mm</p>		<p>9331 7730 0000 with 0.2 m Cable and Socket</p> <p>9331 7700 0000 with 3 m Cable and Plug with 5 m Cable and Plug</p>	<table border="1"> <tr> <td>•</td> <td>•</td> <td>•</td> <td></td> <td></td> <td></td> </tr> <tr> <td>•</td> <td>•</td> <td>•</td> <td></td> <td></td> <td></td> </tr> </table>	•	•	•				•	•	•			
•	•	•													
•	•	•													
<p>DVI-I Connector</p> <p>Dual Link. 24+5 pole. for digital and analogue signals Angled outlet with labeling field Installation dimensions: 50 x 50 mm</p>		<p>9331 7740 0000 with 0.2 m Cable and Socket</p> <p>9331 7710 0000 with 3 m Cable and Plug with 5 m Cable and Plug</p>	<table border="1"> <tr> <td></td> <td></td> <td></td> <td>•</td> <td>•</td> <td></td> </tr> <tr> <td></td> <td></td> <td></td> <td>•</td> <td>•</td> <td></td> </tr> </table>				•	•					•	•	
			•	•											
			•	•											

Description	Picture	Order Nr. & Specifications	<i>/ Dock / R-Dock</i> <i>/ Dock Square</i> <i>/ FlipTop Push</i> <i>/ FrameDock</i> <i>/ One</i> <i>/ Port</i> <i>/ Port Push</i> <i>/ U- & V-Dock</i> <i>/ Up</i>
<p>HDMI-Connector</p> <p>HDMI connector with gilded contacts. Installation dimensions: 25 x 50 mm</p>		<p>9330 6060 0000 HDMI 1.4 connector with 0.3 m Cable and Socket</p> <p>9331 8940 0000 HDMI 2.0 connector with 0.2 m Cable and Socket</p> <p>9330 6070 0000 HDMI 1.4 connector with 3 m Cable and Plug with 5 m Cable and Plug</p> <p>9332 2800 0000 HDMI 2.0 connector with 3 m Cable and Plug</p>	<p>• •</p> <p>• •</p> <p>• •</p> <p>• •</p>
<p>HDMI-Connector</p> <p>Angled outlet with labeling field HDMI 1.4 connector with gilded contacts. Installation dimensions: 50 x 50 mm</p>		<p>9330 6080 0000 HDMI 1.4 connector with 0.3 m Cable and Socket</p> <p>9331 8950 0000 HDMI 2.0 connector with 0.2 m Cable and Socket</p> <p>9330 6090 0000 HDMI 1.4 connector with 3 m Cable and Plug with 5 m Cable and Plug</p> <p>9332 2810 0000 HDMI 2.0 connector with 3 m Cable and Plug</p>	<p>• •</p> <p>• •</p> <p>• •</p> <p>• •</p>
<p>DisplayPort-Connector</p> <p>for digital signals DP 1.2 compliant. Installation dimensions: 25 x 50 mm</p>		<p>9331 7510 0000 with 0.4 m Cable and Socket</p>	<p>• •</p>
<p>DisplayPort-Connector</p> <p>Angled outlet with labeling field for digital signals DP 1.2 compliant. Installation dimensions: 50 x 50 mm</p>		<p>9331 7520 0000 with 0.4 m Cable and Socket</p>	<p>• •</p>





Description	Picture	Order Nr. & Specifications	<i>Dock / R-Dock</i> <i>Dock Square</i> <i>FlipTop Push</i> <i>FrameDock</i> <i>One</i> <i>Port</i> <i>Port Push</i> <i>U- & V-Dock</i> <i>Up</i>
<p>USB 3.0 Connector</p> <p>USB 3.0 Type A socket for connection of USB standard consumer devices. Data rate up to 5 GBit/s Installation dimensions: 25 x 50 mm.</p>		<p>9331 8620 0000 0.2 m Cable and Socket</p> <p>9331 1450 0000 1 m USB Cable Plug USB 3 Type A</p> <p>9331 1460 0000 3 m USB Cable Plug USB 3 Type A</p>	<p>• • •</p> <p>• • •</p> <p>• • •</p>
<p>USB 3.0 Connector</p> <p>USB 3.0 Type A socket for connection of USB standard consumer devices. Data rate up to 5 GBit/s Angled outlet with labeling field Installation dimensions: 50 x 50 mm</p>		<p>9331 8630 0000 0.2 m Cable and Socket</p> <p>9331 1460 0000 1 m USB Cable, Plug USB 3 Type A</p> <p>9331 1460 0000 3 m USB Cable Plug USB 3 Type A</p>	<p>• •</p> <p>• •</p> <p>• •</p>
<p>USB 3.1 Connector</p> <p>USB 3.1 type C suitable for power supply. Max. Current: 3A.</p> <p>Installation dimensions: 25 x 50 mm</p>		<p>9331 9710 0000 0.2 m USB Cable Socket USB 3.1 Type C</p>	<p>• • •</p>
<p>USB 3.1 Connector</p> <p>USB 3.1 type C Angled outlet with labeling field. suitable and power supply. Max. Current: 3A.</p> <p>Installation dimensions: 50 x 50 mm</p>		<p>9331 9870 0000 0.2 m USB Cable Socket USB 3.1 Type C</p>	<p>• •</p>

Description	Picture	Order Nr. & Specifications	/ Dock / R-Dock / Dock Square / FlipTop Push / FrameDock / One / Port / Port Push / U- & V-Dock / Up
<p>Audio Connector and stainless steel push-button with ring LED</p> <p>1x Stereo Jack Socket 3.5 mm 1x Push-Button Operating voltage: 24 V_{AC/DC} Operating current: 10 mA Angled outlet and labeling field</p> <p>Installation dimensions: 50 x 50 mm</p>		<p>9331 9490 0000</p> <p>Audio Stereo Jack Socket 3.5 mm with 3 m Cable and Plug 3.5 mm</p> <p>Push-Button with 3 m Cable without plug</p>	• •
<p>Audio Connector and Data Socket Reichle & De-Massari Cat. 6</p> <p>1x Stereo Jack socket 3.5 mm 1x Data Socket with cable Angled outlet with labeling field</p> <p>Installation dimensions: 50 x 50 mm</p>		<p>9330 7610 0000</p> <p>Audio Stereo Jack Socket 3.5 mm with 3 m Cable and Plug 3.5 mm</p> <p>Data RJ45 Cat. 6 Socket with 3 m Cable, shielded and RJ45 Plug</p>	• •
<p>Audio Connector and Data Socket Elbro</p> <p>1x Cat.6 Modular-Adaptor, shielded 1x Stereo Jack socket 3.5 mm Angled outlet with labeling field</p> <p>Installation dimensions: 50 x 50 mm</p>		<p>9330 7800 0000</p> <p>Audio Stereo Jack Socket 3.5 mm with 3 m Cable and Plug 3.5 mm</p> <p>Data Modular-Adaptor RJ45 (without Cable)</p>	• •
<p>HDMI and Audio Socket 3.5mm</p> <p>1x HDMI 1.4 connector with gilded contacts. 1x Stereo Jack socket 3.5 mm Angled outlet with labeling field</p> <p>Installation dimensions: 50 x 50 mm</p>		<p>9331 5100 0000</p> <p>Audio Stereo Jack Socket 3.5 mm with 3 m Cable and Plug 3.5 mm</p> <p>HDMI with 3 m Cable and Plug</p>	• •



Description	Picture	Order Nr. & Specifications	Dock / R-Dock Dock Square FlipTop Push FrameDock One Port Port Push U- & V-Dock Up																																								
<p>Cable Outlet Module</p> <p>1 cable passage Colour: black</p> <p>Installation dimensions: 50 x 50 mm</p>		<p>9331 3790 0000 Ø 8 mm</p> <p>9331 0560 0000 Ø 12 mm</p> <p>9331 1670 0000 Ø 17 mm</p> <p>Additional diameters on demand</p>	<table border="1"> <tr><td>•</td><td>•</td><td>•</td><td>•</td></tr> <tr><td>•</td><td>•</td><td>•</td><td>•</td></tr> <tr><td>•</td><td>•</td><td>•</td><td>•</td></tr> </table>	•	•	•	•	•	•	•	•	•	•	•	•																												
•	•	•	•																																								
•	•	•	•																																								
•	•	•	•																																								
<p>Cable Outlet Module</p> <p>2 cable passages Colour: black</p> <p>Installation dimensions: 50 x 50 mm</p>		<p>9331 3800 0000 Ø 8 mm</p> <p>9331 1930 0000 Ø 12 mm</p> <p>Additional diameters on demand</p>	<table border="1"> <tr><td>•</td><td>•</td><td>•</td><td>•</td></tr> <tr><td>•</td><td>•</td><td>•</td><td>•</td></tr> </table>	•	•	•	•	•	•	•	•																																
•	•	•	•																																								
•	•	•	•																																								
<p>Cable Guide Modul</p> <p>Clamp for 3 cables 2x 8 mm 1x 12 mm Colour: black</p> <p>Installation dimensions: 25 x 50 mm</p>		<p>9331 3600 0000 Holder for 3 Cables</p>	<table border="1"> <tr><td></td><td></td><td></td><td>•</td></tr> </table>				•																																				
			•																																								
<p>Cable assortment</p> <p>3.0 m cables 2 plugs</p> <p>cable extension and variations available on request</p>		<p>9331 0350 0000 HDMI Cable</p> <p>9331 3060 0000 VGA Cable</p> <p>9331 3760 0000 Displayport Cable</p> <p>9331 3720 0000 Audio Stereo Cable</p> <p>9331 1060 0000 PatchCable CAT6, shielded</p> <p>9331 9810 0000 USB 3.0 Cable (Type A)</p>	<table border="1"> <tr><td>•</td><td>•</td><td>•</td><td>•</td><td>•</td><td>•</td><td>•</td><td>•</td></tr> <tr><td>•</td><td>•</td><td>•</td><td>•</td><td>•</td><td>•</td><td>•</td><td>•</td></tr> <tr><td>•</td><td>•</td><td>•</td><td>•</td><td>•</td><td>•</td><td>•</td><td>•</td></tr> <tr><td>•</td><td>•</td><td>•</td><td>•</td><td>•</td><td>•</td><td>•</td><td>•</td></tr> <tr><td>•</td><td>•</td><td>•</td><td>•</td><td>•</td><td>•</td><td>•</td><td>•</td></tr> </table>	•	•	•	•	•	•	•	•	•	•	•	•	•	•	•	•	•	•	•	•	•	•	•	•	•	•	•	•	•	•	•	•	•	•	•	•	•	•	•	•
•	•	•	•	•	•	•	•																																				
•	•	•	•	•	•	•	•																																				
•	•	•	•	•	•	•	•																																				
•	•	•	•	•	•	•	•																																				
•	•	•	•	•	•	•	•																																				





Description	Picture	Order Nr. & Specifications	/ Dock / R-Dock / / Dock Square / / FlipTopPush / / FrameDock / / One / / Port / / PortPush / / U- & V-Dock / / Up /
Installation Space		9330 7990 0000 Profile length: 15 mm	• • • •
Profile with black plastic cover to enable later insertation of additional modules.		9330 5620 0000 Profile length: 25 mm	• • • •
		9330 5630 0000 Profile length: 50 mm	• • • •
		9330 5640 0000 Profile length: 75 mm	• • • •
		9330 5650 0000 Profile length: 100 mm	• • • •
		9330 6390 0000 Profile length: 150 mm	• • • •
		9330 9000 0000 black	• • • • • • •
Labeling Field		For individual labeling of modules.	
Installation dimensions: 15 x 50 mm			
Cover Plate		9330 0150 0000 Dimensions: 5 x 50 mm	• • • • • • •
made of black plastic, provides distance between current modules, future changes are not possible		9330 7980 0000 Dimensions: 15 x 50 mm	• • • • • • •
		9330 0920 0000 Dimensions: 25 x 50 mm	• • • • • • •
		9330 0130 0000 Dimensions: 50 x 50 mm	• • • • • • •
		9330 0550 0000 Dimensions: 75 x 50 mm	• • • • • • •
		9330 0110 0000 Dimensions: 100 x 50 mm	• • • • • • •
		9330 7650 0000 Dimensions: 150 x 50 mm	• • • • • • •



EVOLine® Switches and Push-Buttons

Description	Picture	Order Nr. & Specifications	<i>Dock / R-Dock</i> <i>Dock Square</i> <i>Flip Top Push</i> <i>FrameDock</i> <i>One</i> <i>Port</i> <i>Port Push</i> <i>U- & V-Dock</i> <i>Up</i>
<p>ON / OFF switch</p> <p>230 V, 2-pole, illuminated in blue. For switching built-in sockets or for external assignment. Installation dimensions: 50 x 50 mm</p>		9330 0010 0000	• • • • • • • •
<p>ON / OFF switch</p> <p>230 V, 2-pole, illuminated in blue. With lamp symbol For switching built-in sockets or for external assignment. Installation dimensions: 50 x 50 mm</p>		9330 6650 0000	• • • • • • • •
<p>ON / OFF switch</p> <p>230 V, 2-pole, illuminated in blue. With lamp symbol For switching built-in sockets or for external assignment. Installation dimensions: 50 x 50 mm</p>		9330 6660 0000	• • • • • • • •
<p>1x Stainless steel pushbutton with blue LED ring</p> <p>Pushbutton potential-free Switching data: 240 V ≈ / 3 A LED can be connected separately. LED operating data: 24 V ≈ / 7 mA</p> <p>Installation dimensions: 25 x 50 mm</p>		<p>9331 9300 0000 with Screw terminals</p> <p>9331 9240 0000 with 3 m cable and ferrules</p>	• • • • • • • • • • • • • • • •

Dock / R-Dock
 Dock Square
 FlipTop Push
 FrameDock
 One
 Port
 Port Push
 U- & V-Dock
 Up

Description	Picture	Order Nr. & Specifications	
<p>1x Stainless steel pushbutton with blue LED ring, angled outlet</p> <p>Pushbutton potential-free Switching data: 240 V = / 3 A LED can be connected separately. LED operating data: 24 V = / 7 mA, labeling field Installation dimensions: 50x50 mm</p>		<p>9331 9320 0000 with Screw terminals</p> <p>9331 9260 0000 with 3 m cable and ferrules</p>	<div style="display: flex; justify-content: space-around;"> <div style="width: 20px; height: 100%; background-color: #ccc;"></div> <div style="width: 20px; height: 100%; background-color: #ccc;"></div> <div style="width: 20px; height: 100%; background-color: #ccc;"></div> <div style="width: 20px; height: 100%; background-color: #ccc;"></div> <div style="width: 20px; height: 100%; background-color: #ccc;"></div> <div style="width: 20px; height: 100%; background-color: #ccc;"></div> </div>
<p>1x Stainless steel pushbutton with blue LED ring, angled outlet</p> <p>Pushbutton potential-free Switching data: 240 V = / 3 A LED can be connected separately. LED operating data: 24 V = / 7 mA Angled outlet with labeling field Installation dimensions: 50x50 mm</p>		<p>9331 9330 0000 with Screw terminals</p> <p>9331 9270 0000 with 3 m cable and ferrules</p>	<div style="display: flex; justify-content: space-around;"> <div style="width: 20px; height: 100%; background-color: #ccc;"></div> <div style="width: 20px; height: 100%; background-color: #ccc;"></div> <div style="width: 20px; height: 100%; background-color: #ccc;"></div> <div style="width: 20px; height: 100%; background-color: #ccc;"></div> <div style="width: 20px; height: 100%; background-color: #ccc;"></div> <div style="width: 20px; height: 100%; background-color: #ccc;"></div> </div>
<p>Master / Slave Switch 2-pole</p> <p>controls downstream sockets (slave sockets), available only as combination of upstream master and downstream slave sockets</p> <p>Switching threshold: adjustable from 20 to 100 mA, Rated voltage: 250 V, Rated current: 16 A, 2-pole, Protection class IP20, black plastic frame</p> <p>Installation dimensions: 75 x 50 mm</p>		<p>9330 6160 0000</p>	<div style="display: flex; justify-content: space-around;"> <div style="width: 20px; height: 100%; background-color: #ccc;"></div> <div style="width: 20px; height: 100%; background-color: #ccc;"></div> <div style="width: 20px; height: 100%; background-color: #ccc;"></div> <div style="width: 20px; height: 100%; background-color: #ccc;"></div> <div style="width: 20px; height: 100%; background-color: #ccc;"></div> <div style="width: 20px; height: 100%; background-color: #ccc;"></div> </div>

Description	Picture	Order Nr. & Specifications	/ Dock / R-Dock / Dock Square / FlipTop Push / FrameDock / One / Port / Port Push / U- & V-Dock / Up /
<p>Residual Current Device</p> <p>RCD/RCCB 2-pole characteristic B, type A</p> <p>Installation dimensions: 100 x 50 mm</p>		<p>9330 0370 0000 Rated current: 25 A Rated fault current: 30 mA</p> <p>9330 8260 0000 Rated current: 16 A Rated fault current: 10 mA</p>	<p>• • • • •</p> <p>• • • • •</p>
<p>Circuit Breaker MCB</p> <p>2-pole characteristic B</p> <p>Installation dimensions: 100 x 50 mm</p>		<p>9330 1140 0000 Rated current: 10 A</p> <p>9330 1150 0000 Rated current: 13 A</p> <p>9330 0400 0000 Rated current: 16 A</p>	<p>• • • • •</p> <p>• • • • •</p> <p>• • • • •</p>
<p>FI/LS-switch</p> <p>RCBO pulse-current sensitive type A characteristic B</p> <p>Einbaumaß: 100 x 50 mm</p>		<p>9311 8860 0000 Rated current: 25 A Rated fault current: 30 mA</p>	<p>• • • • •</p>
<p>Surge Protector</p> <p>With optical indicator</p> <p>Installation dimensions: 50 x 50 mm</p>		<p>9331 4770 0000 rated leakage current 1,5 kA maximum leakage current 5 kA,</p>	<p>• • • • •</p>
<p>Overvoltage protector</p> <p>Model like WAGO WINSTA Midi or Wieland GST 18i3 Protection level UP L/N PE 1.5KV</p>		<p>1599 0910 4100 Model WAGO WINSTA MIDI</p> <p>1599 0910 4000 Model Wieland GST 18i3</p>	<p>• • • • •</p> <p>• • • • •</p>

Description	Picture	Order Nr. & Specifications	Dock / R-Dock Dock Square FlipTop Push FlameDock One Port Port Push U- & V-Dock Up
<p>Overload Circuit Breaker</p> <p>required for 3 sockets or more in Australia. 1-pole. Type: Sliding switch</p> <p>Installation dimensions: 25 x 50 mm</p>		<p>9330 5840 0000 Australien 10 A, 250 V</p>	• • • • • • •
<p>Overload Circuit Breaker</p> <p>Switch-on overload switch Installation dimensions: 25 x 50 mm</p>		<p>9332 1080 0000 Switzerland Fuse: 10 A, 230 V~</p> <p>9332 0380 6600 U.S.A. (from the 4th socket) Fuse: 15 A, 125 V~</p>	• • • • • • • • • • • • • •
<p>Power Supply Module with Cable and Overload Circuit Breaker</p> <p>Plug Type: J (T13) Switch-on overload switch (10 A) 3 x 1,5 mm² e.g. Schweiz</p>		<p>9332 1090 0000 Cable length 3 m mounted to product</p>	• • • • • • •

EVoline® Interchangeable Modules





How to change Interchangeable Modules

Both the FlipTop *Push* and the FrameDock can be individually equipped with data- and multimedia modules.

Should the usage requirements change in the workspace over time, data modules and cable can be replaced without the Port Push, DockSquare, FlipTop *Push* or FrameDock must be removed previously. Of course you can replace the modules between the profiles. *



Releasing the interchangeable module with simple instruments like screwdrivers. Now another interchangeable module can be mounted to the System
(this example: FrameDock).



* Except for Port Push.

Combination of Interchangeable Modules

Your usage requirements are as flexible as you are.

So that your workspace keeps tailored to you, you always can equip your system with a new interchangeable module.

Single Modules

Interchangeable Modules

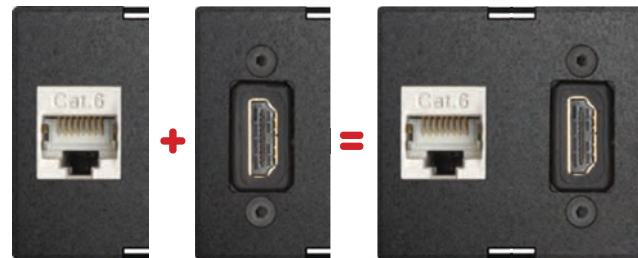
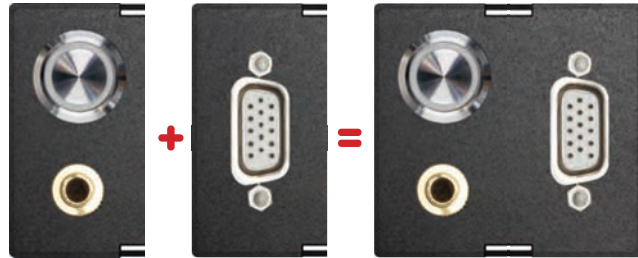

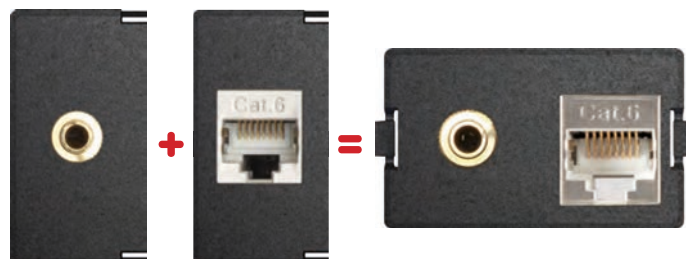

Examples for the configuration of the interchangeable Modules of FlipTop Push, FrameDock and Dock Square





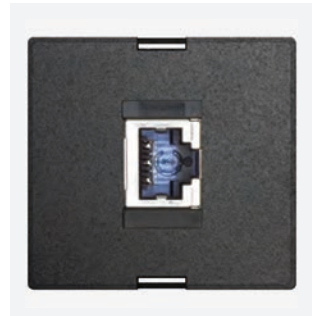

Examples for the configuration of the interchangeable Modules of Port Push









FlipTop Push
FrameDock
V-Dock
Dock Square
Port Push

Description	Picture	Order Nr. & Specifications	
<p>RJ45 Modular Adaptor ELBRO</p> <p>RJ45 to RJ45, 1:1 interconnected for Patch cable.</p> <p>1/2 Module</p>		<p>9331 9010 0000 RJ45 CAT6 unshielded socket to socket (RJ45), without cable</p> <p>9331 8090 0000 RJ45 CAT6 shielded socket to socket (RJ45), without cable</p> <p>9331 8290 0000 RJ45 CAT6A shielded socket to socket (RJ45), without cable</p>	<p>• • • • •</p> <p>• • • • •</p> <p>• • • • •</p>
<p>Data Plate with Data Socket Reichle & De-Massari</p> <p>With Cable</p> <p>1/2 Module</p>		<p>9331 8420 0000 RJ45 Cat6 shielded with 0,2 m cable and socket</p> <p>9331 8410 0000 RJ45 Cat6 unshielded with 3m cable and plug</p> <p>9331 8070 0000 RJ45 Cat6 shielded with 3m cable and plug</p> <p>9331 8400 0000 RJ45 Cat6A shielded with 3m cable and plug</p>	<p>• • • • •</p> <p>• • • • •</p> <p>• • • • •</p> <p>• • • • •</p>
<p>Data Plate with Data Socket Reichle & De-Massari</p> <p>With Cable</p> <p>1/1 Module</p>		<p>9331 8420 2200 RJ45 Cat6 shielded with 0,2 m cable and socket</p> <p>9331 8410 2200 RJ45 Cat6 unshielded with 3m cable and plug</p> <p>9331 8070 2200 RJ45 Cat6 shielded with 3m cable and plug</p> <p>9331 8400 2200 RJ45 Cat6A shielded with 3m cable and plug</p>	<p>• • • • •</p> <p>• • • • •</p> <p>• • • • •</p> <p>• • • • •</p>



FlipTop Push
FrameDock
V-Dock
Dock Square
Port Push





Description	Picture	Order Nr. & Specifications	
<p>VGA-Connector</p> <p>15 pole HDD socket with screw connector</p> <p>1/2 Module</p>		<p>9331 8550 0000 with socket–socket (without cable)</p> <p>9331 8430 0000 with 0.2 m cable and socket</p> <p>9331 8100 0000 with 3 m cable and plug</p>	<p>• • • • •</p> <p>• • • • •</p> <p>• • • • •</p>
<p>VGA-Connector</p> <p>15 pole HDD socket with screw connector</p> <p>1/1 Module</p>		<p>9331 8550 2200 with socket–socket (without cable)</p> <p>9331 8430 2200 with 0.2 m cable and socket</p> <p>9331 8100 2200 with 3 m cable and plug</p>	<p>• • • • •</p> <p>• • • • •</p> <p>• • • • •</p>
<p>Audio Connector 3,5 mm</p> <p>1x Stereo Jack socket 3.5 mm</p> <p>1/2-Module</p>		<p>9331 8220 0020 with 0.2 m cable and socket</p> <p>9331 8220 0000 with 3 m cable and socket</p> <p>9331 8210 0000 3 m cable and plug</p>	<p>• • • • •</p> <p>• • • • •</p> <p>• • • • •</p>
<p>Audio Connector 3,5 mm</p> <p>1x Stereo Jack socket 3.5 mm</p> <p>1/2-Module</p>		<p>9331 8220 2220 with 0.2 m cable and socket</p> <p>9331 8220 2200 with 3 m cable and socket</p> <p>9331 8210 2200 with 3 m cable and plug</p>	<p>• • • • •</p> <p>• • • • •</p> <p>• • • • •</p>

FlipTop Push
FrameDock
V-Dock
Dock Square
Port Push

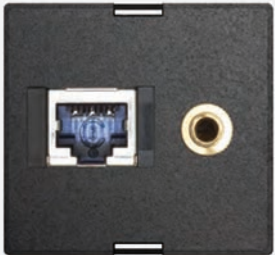
Description	Picture	Order Nr. & Specifications	
<p>Stainless steel pushbutton with blue LED ring</p> <p>Pushbutton potential-free Switching data: 240 VAC/DC, 3 A LED can be connected separately. LED operating data: 24 VAC/DC, 7 mA</p> <p>1/2 Module</p>		<p>9331 8870 0000 with Screw terminals</p> <p>9331 8850 0000 with 3 m cable</p>	
<p>Stainless steel pushbutton with blue LED ring</p> <p>Pushbutton potential-free Switching data: 240 V~/ 3 A LED can be connected separately LED operating data: 24 V~/ 7 mA</p> <p>1/1 Module</p>		<p>9331 8870 2200 with Screw terminals und blauer Ring-LED</p> <p>9331 8850 2200 with 3 m cable</p>	
<p>Audio connector and stainless steel pushbutton with blue LED ring</p> <p>1x stereo jack socket 3.5 mm 1x pushbutton, potential-free Switching data: 240 V~/ 3 A LED can be connected separately LED operating data: 24 V~/ 7 mA</p> <p>1/2 module</p>		<p>9331 8880 0000 Audio 3 m cable</p> <p>Pushbutton 3 m cable</p>	
<p>Audio connector and stainless steel pushbutton with blue LED ring</p> <p>1x stereo jack socket 3.5 mm 1x pushbutton, potential-free Switching data: 240 V~/ 3 A LED can be connected separately LED operating data: 24 V~/ 7 mA</p> <p>1/1 module</p>		<p>9331 8880 2200 Audio 3 m cable</p> <p>Pushbutton 3 m cable</p>	



FlipTop Push
 FrameDock
 V-Dock
 Dock Square
 Port Push

Description	Picture	Order Nr. & Specifications				
<p>HDMI-, VGA- and Audioconnector</p> <p>HDMI 1.4 socket with gilded Contacts, 15 pole HDD VGA socket, Stereo Jack socket with cable</p> <p>1/1 Module</p>		<p>9331 9000 0000 HDMI, VGA, Audio: Each with 3 m cable and plug</p>	●	●	●	●
		<p>9331 9000 0000 HDMI, VGA, Audio: Each with 5 m cable and plug</p>	●	●	●	●
		<p>9331 9410 0000 HDMI, VGA, Audio: 0,2 m cable and socket</p>	●	●	●	●
<p>Audio-Connector 3,5 mm with CAT6-Data socket Reichle & De-Massari</p> <p>1 × Stereo Jack socket, 1 × Data socket</p> <p>1/2-Module</p>		<p>9331 8680 0000 Audio: Connector 3,5 mm with 3 m cable and plug</p> <p>Data RJ45 Cat.6 shielded 3 m cable and plug</p>	●	●	●	●
<p>Audio-Connector 3,5 mm with CAT6-Data socket Reichle & De-Massari</p> <p>1 × Stereo Jack socket, 1 × Data socket</p> <p>1/1-Module</p>		<p>9331 8680 2200 Audio: Connector 3,5 mm with 3 m cable and plug</p> <p>Data RJ45 Cat.6 shielded 3 m cable and plug</p>	●	●	●	●





Description	Picture	Order Nr. & Specifications	
<p>Audio-Connector 3,5 mm with CAT6-Data socket ELBRO</p> <p>1 × Stereo Jack socket 1 × Modular adaptor RJ45 RJ45, 1:1 interconnected for Patch cable</p> <p>1/2 Module</p>		<p>9331 8690 0000 Audio: Connector 3,5 mm with 3 m cable</p> <p>Data socket to socket RJ45 Cat.6 shielded</p> <p>9332 0110 0000 Audio: Connector 3,5 mm without cable</p> <p>Data socket to socket RJ45 Cat.6 shielded</p>	
<p>Audio-Connector 3,5 mm with CAT6-Data socket ELBRO</p> <p>1 × Stereo Jack socket, 1 × Cat.6 Module adaptor</p> <p>1/1 Module</p>		<p>9331 8690 2200 Audio: Connector 3,5 mm with 3 m cable</p> <p>Data RJ45 Cat.6 shielded socket to socket RJ45</p> <p>9331 0110 2200 Audio: Connector 3,5 mm without cable</p> <p>Data RJ45 Cat.6 shielded socket to socket RJ45</p>	

FlipTop Push
FrameDock
V-Dock
Dock Square
Port Push











Description	Picture	Order Nr. & Specifications	
<p>DVI-I Connector</p> <p>Dual-Link, 24 + 5 pole</p> <p>1/2 Module</p>		<p>9331 8110 0000 with 0.2 m cable and socket</p> <p>9331 8440 0000 with 3 m cable and plug with 5 m cable and plug</p>	<p>• • • • •</p> <p>• • • • •</p>
<p>DVI-I Connector</p> <p>Dual-Link, 24 + 5 pole</p> <p>1/1 Module</p>		<p>9331 8110 2200 with 0.2 m cable and socket</p> <p>9331 8440 2200 with 3 m cable and plug</p>	<p>• • • • •</p> <p>• • • • •</p>
<p>HDMI-Connector</p> <p>with gilded contacts</p> <p>1/2 Module</p>		<p>9331 8540 0000 HDMI 1.4 with socket – socket (without cable)</p> <p>9331 8120 0000 HDMI 1.4 with 0.2 m cable and socket</p> <p>9331 9540 0000 HDMI 2.0 with 0.2 m cable and socket</p> <p>9331 8130 0000 HDMI 1.4 with 3 m cable and plug with 5 m cable and plug</p> <p>9332 2820 0000 HDMI 2.0 with 3 m cable and plug</p>	<p>• • • • •</p> <p>• • • • •</p> <p>• • • • •</p> <p>• • • • •</p> <p>• • • • •</p>

Description	Picture	Order Nr. & Specifications	
<p>HDMI-Connector</p> <p>with gilded contacts</p> <p>1/1 Module</p>		<p>9331 8120 2200 HDMI 1.4 with 0.2 m cable and socket</p> <p>9331 9540 2200 HDMI 2.0 with 0.2 m cable and socket</p> <p>9331 8130 2200 HDMI 1.4 with 3 m cable and plug with 5 m cable and plug</p> <p>9331 2280 2200 HDMI 2.0 with 3 m cable and plug</p>	<p>• • • •</p> <p>• • • •</p> <p>• • • •</p> <p>• • • •</p>
<p>Display Port-Connector</p> <p>DP 1.2 compliant</p> <p>1/2 Module</p>		<p>9331 8140 0000 with 0.4 m cable and socket</p>	<p>• • • • •</p>
<p>Display Port-Connector</p> <p>DP 1.2 compliant</p> <p>1/1 Module</p>		<p>9331 8140 2200 with 0.4 m cable and socket</p>	<p>• • • •</p>

FlipTop Push
FrameDock
V-Dock
Dock Square
Port Push

Description	Picture	Order Nr. & Specifications	
<p>USB-Connector 3.0</p> <p>USB 3.0 Type A</p> <p>1/2-Module</p>		<p>9331 8530 0000 with socket – socket Type A</p> <p>9331 8650 0000 with 0.2 m cable and socket</p> <p>9331 8460 0000 with 3 m cable and plug</p>	<p>• • • • •</p> <p>• • • • •</p> <p>• • • • •</p>
<p>USB-Connector 3.0 Type A</p> <p>USB 3.0 Type A</p> <p>1/1-Module</p>		<p>9331 8650 2200 with 0.2 m cable and socket</p> <p>9331 8460 2200 with 3 m cable and plug</p>	<p>• • • •</p> <p>• • • •</p>
<p>USB-Connector 3.1 Type C</p> <p>USB 3.1 type C</p> <p>Suitable just for power supply. Max. current: 3 A</p> <p>1/2 Module</p>		<p>9331 9720 0000 with 0.2 m USB cable and socket</p>	<p>• • • • •</p>
<p>USB-Connector 3.1 Type C</p> <p>USB 3.1 type C</p> <p>Suitable just for power supply. Max. current: 3 A</p> <p>1/1 Module</p>		<p>9331 9720 2200 with 0.2 m USB cable and socket</p>	<p>• • • •</p>

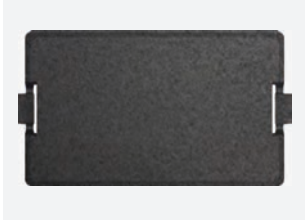
Technical changes and printing errors reserved. | Similar pictures.

Description	Picture	Order Nr. & Specifications	/ FlipTop Push / FrameDock / V-Dock / Dock Square / Port Push /
<p>WireLane Adaptor for FlipTop Push</p> <p>to connect the WireLane</p>		<p>9331 8700 0000 black</p>	
<p>Cable Outlet Module</p> <p>for one cable like: Patch cable, audio cable etc.</p> <p>1/1 module</p>		<p>9331 8230 0000 Empty module, without cable</p>	
<p>Cable Outlet Module</p> <p>for one cable like: Patch cable, audio cable etc.</p>		<p>9332 0100 0000 Empty module, without cable</p>	
<p>Installation Space</p> <p>Profile to enable later insertion of interchangeable modules</p>		<p>9331 8300 0000</p>	
<p>Installation Space for EVOLine Port Push</p> <p>Profile to enable later insertion of interchangeable modules</p>		<p>9332 1410 0000</p>	

EVoline® Kinetics





Remote on/off control without cable or battery from a distance.

EVoline[®] Kinetics

EVoline Kinetics modules make it possible. Touching the switch with a finger generates enough energy to send an encoded wireless signal as far as 30 metres in enclosed spaces.

The EVoline receiver can be integrated into our products to switch electrical sockets. The transmitters can also be installed in EVoline products. Alternatively, they can be freely positioned with a mounting frame.



Description	Picture	Order Nr. & Specifications	<div style="display: flex; flex-direction: column; align-items: center; gap: 5px;"> / Dock / R-Dock / Dock Square / FlipTop Push / FrameDock / One / Port / Port Push / U- & V-Dock / Up </div>
<p>Kinetics Wireless Receiver 2 pole module</p> <p>switching states ON/OFF, with display switching status, green, 230 V~ Actuator Switching capacity of max. 16 A, switches devices such as lights, for EnOcean Alliance transmitters</p> <p>installation dimensions: 75 x 50 mm</p>		<p>9330 6400 0000 Module may be ordered in assembled products</p>	<div style="display: flex; justify-content: space-around;"> <div style="width: 20px; height: 150px; background-color: #ccc; position: relative;"> ● </div> <div style="width: 20px; height: 150px; background-color: #ccc; position: relative;"> ● </div> <div style="width: 20px; height: 150px; background-color: #ccc; position: relative;"> ● </div> <div style="width: 20px; height: 150px; background-color: #ccc; position: relative;"> ● </div> </div>
<p>Kinetics Wireless Transmitter Built-in module</p> <p>Controls all receivers of the EnOcean Alliance. Range up to 30 m.</p> <p>Installation dimensions: 50 x 50 mm</p>		<p>9330 6420 0000 with 1 rocker switch and 1 labelling field</p> <p>9330 6410 0000 with 2 rocker switches and 2 labelling fields</p>	<div style="display: flex; justify-content: space-around;"> <div style="width: 20px; height: 150px; background-color: #ccc; position: relative;"> ● </div> <div style="width: 20px; height: 150px; background-color: #ccc; position: relative;"> ● </div> <div style="width: 20px; height: 150px; background-color: #ccc; position: relative;"> ● </div> <div style="width: 20px; height: 150px; background-color: #ccc; position: relative;"> ● </div> </div>
<p>Kinetics Wireless Transmitter with frame</p> <p>to switch on/off Controls all EnOcean receivers, range up to 30 m</p> <p>Installation dimensions: 60 x 65 mm</p>		<p>1599 0907 6900 with 1 rocker switch and 1 labelling field, black frame</p> <p>1599 0907 8200 with 1 rocker switch and 1 labelling field, pure white frame</p> <p>1599 0907 6800 with 2 rocker switches and 2 labelling fields, black frame</p> <p>1599 0907 8100 with 2 rocker switches and 2 labelling fields, pure white frame</p>	<div style="display: flex; justify-content: space-around;"> <div style="width: 20px; height: 150px; background-color: #ccc; position: relative;"> ● </div> <div style="width: 20px; height: 150px; background-color: #ccc; position: relative;"> ● </div> <div style="width: 20px; height: 150px; background-color: #ccc; position: relative;"> ● </div> <div style="width: 20px; height: 150px; background-color: #ccc; position: relative;"> ● </div> </div>

EVoline® Plug



reddot design award
winner 2011

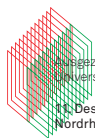

Ausgezeichnet mit dem 1. Preis
Universal Home: Product Design
1. Designpreis des Landes
Nordrhein-Westfalen



Designpreis
Deutschland
2011
NOMINIERT



interior
innovation
award
2011
Winner



Ausgezeichnet with der
IENA Goldmedaille



universal
design
award 2010



universal
design
consumer
favorite 2010



DOBRY
WZÓR
2012

Extremely thin. Fits behind any cupboard or cabinet. Prevents tripping hazards.

EVoline[®] Plug | PlugFix

The EVoline Plug's ultra-low profile easily fits behind any piece of furniture. The intelligent joint mechanism transforms the handle into a lever – and the plug can be easily removed from the socket. Even in case of a pull on the cable, the plug is released without damage.

EVoline Plug Fix as flat plug solution for manufacturers cannot be dismantled. Our range offers versions with wire end ferrules, couplings, 3-gang socket rail or connectors.

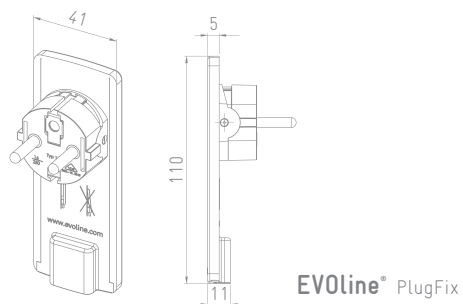
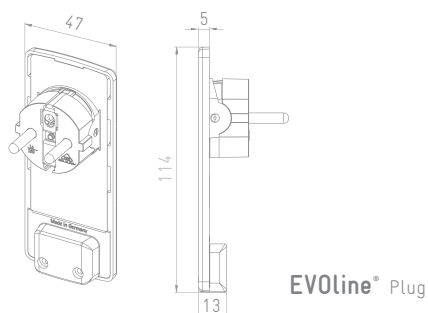

Dimensions in mm



**Only with
EVOLine Plug:**

Movable plug face
for ease of use and
to prevent tripping
hazards



PlugFix

With fixed cable
for OEM volume
orders.



Only 5 mm

housing thickness

EVoline® Plug | PlugFix

Description	Picture	Specifications	Order Number
<p>EVoline Plug</p> <p>Screwable ultra-low profile grounded plug with movable face, for wire diameters of 0.75 mm² to 1.5 mm², 250 V / 16 A</p>		<p>black</p> <p>white</p>	<p>1510 0000 0100</p> <p>1510 0000 0300</p>
<p>EVoline PlugFix</p> <p>Ultra-low profile grounded plug with movable face, with cable 3 × 1.5 mm² connected to 3 gang power bar EVoline Express, 250 V / 16 A</p>		<p>black, with 1.5 m Cable</p> <p>white, with 1.5 m Cable</p>	<p>1510 0015 6100</p> <p>1510 0015 6300</p>
<p>EVoline PlugFix</p> <p>Ultra-low profile grounded plug with movable face, with cable 3 × 1.5 mm² connected to socket coupling with contact protection, 250 V / 16 A</p>		<p>black, with 3 m Cable</p> <p>black, with 1.5 m Cable</p> <p>white, with 3 m Cable</p> <p>white, with 1.5 m Cable</p>	<p>1510 0030 5100</p> <p>1510 0015 5100</p> <p>1510 0030 5300</p> <p>1510 0015 5300</p>
<p>EVoline PlugFix</p> <p>Ultra-low profile grounded plug with movable face, with cable 3 × 1.5 mm² and connector. Select from Wieland GST18 or WAGO WINSTA sockets.</p>		<p>GST 18i3 black 1.5 m Cable and socket</p> <p>WAGO WINSTA black 1.5 m Cable and socket</p>	<p>1510 0015 2100</p> <p>1510 0015 8100</p>
<p>EVoline PlugFix</p> <p>Ultra-low profile grounded plug with movable face, with Fix</p>		<p>black, with 1.5 m Cable</p> <p>white, with 1.5 m Cable</p>	<p>1510 0015 1100</p> <p>1510 0015 1300</p>

EVoline® Qi Charger



Pure minimalism

EVoline® Qi Charger

EVoline Charger Qi allows charging of any Qi-capable device without cables or any other accessories on a single charging station.

Installed below the desk or work surface makes the charger completely invisible. It also may be mounted into a \varnothing 80 mm opening.

Place the device to be charged simply on the work surface above – pure minimalism.

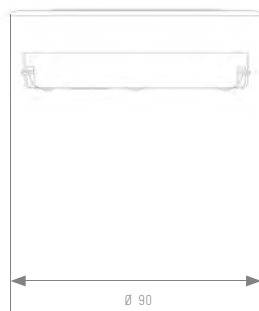

Dimensions in mm

Housing	Plastics, black
Lid	Plastics, black Printing white
Installation	Embedding Mounting
WPC Standard	Spec. 1.2.2 "Qi"
Qi-Certificate	ID 2409

Description	Picture	Specifications	Order Number
-------------	---------	----------------	--------------

EVOLine Qi Charger

Wireless charger according WPC standard Spec. 1.2.2 "Qi".
The coil is mounted below the work surface or is mounted into an opening Ø 80 mm.



USB power supply with Euro plug

1599 0911 2800

Operating voltage 9 V
Charging capacity max. 10 W

Mains adapter:
1.2 m USB connection cable



Wireless charging

- resonant inductive coupling between transmitter (charging station) and receiver (mobile phone)
- vendor independent, charges any Qi compatible device
- transmitter coil is active only when a connection to the receiving device is made

EVoline[®] Express



Cascadable. Extendable. International.

EVoline[®] Express

EVoline Express Type 910 for a consistent modular power supply provides a flexible number of power sockets. Self extinguishing plastics, sockets with contact protection and the testing of every single product before dispatch provides highest safety. Protection and switch modules are available as well.

International socket versions available. Various colours available.

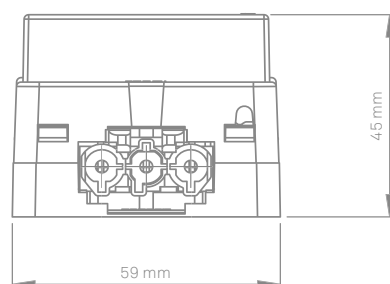
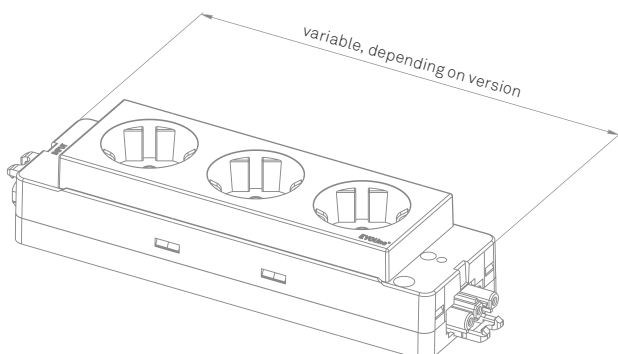

Connecting systems



Wieland GST 18i3
Plug



Wieland GST 18i3
Connector



WAGO WINSTA
Plug



WAGO WINSTA
Connector

Connectivity with EVOLine Express:

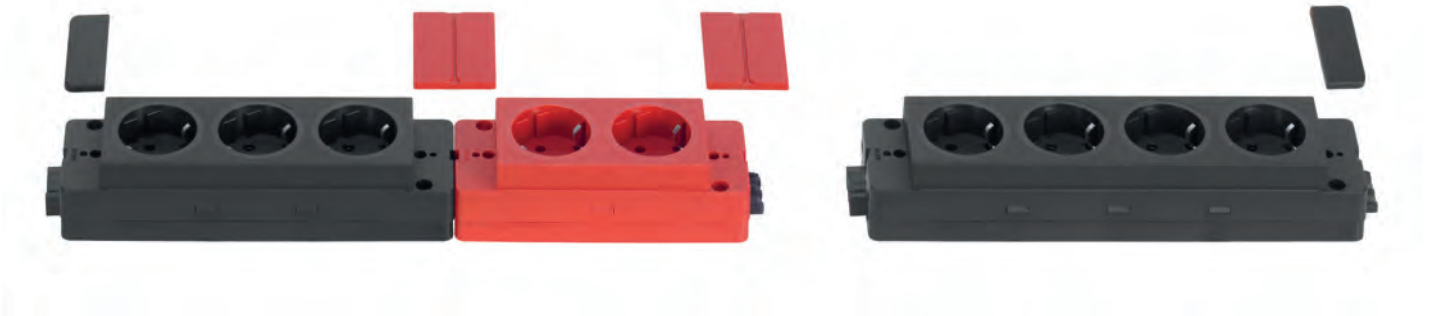



Technical Information for Express Type 910

- Rated voltage: 230 V_{AC}
- Rated current: 16 A
- Halogen free housing
- Connectors for direct connection to each other (loop-through wiring)
- sockets redated through 30° (for example, allows the use of power supplies)
- Trough wiring (solid copper wire) 1.5mm²
- Low heat and high current carrying capacity through copper Contact rails
- Certified according to DIN VDE 0620-1
- Glow-wire test to IEC 60 695-2-11. Self-extinguishing. Flame retardant
- Each item individually tested with test report
- Test Modes: earth bond test. Continuity test. High voltage test
- socket housing: without screws or bolts



GST18® is a brand of WIELAND Electric GmbH



WINSTA® is a brand of WAGO Kontakttechnik GmbH & Co. KG





powerCON is a brand of Neutrik AG









Description	Picture	Specifications	Order Number
EVoline Express lateral cover cap for screw holes (not suitable for Express Type 900 and 907)		Housing Colour black	1591 1830 0400
		Housing Colour red	1591 1830 0500
		Housing Colour green	1591 1830 0700
EVoline Express Type 910 2 gang Power Bar, VDE for plug types: F, E+F, C rated voltage: 250 V / 50 Hz rated current: 16 A halogen-free Dimensions : 46 × 59 × 148 mm		Wieland GST 18	
		without contact protection	
		Housing Colour black	1591 0200 0100
		Housing Colour red	1591 0200 0120
		contact protected	
		Housing Colour black	1591 0200 0110
		Housing Colour red	1591 0200 0130
		WAGO WINSTA MIDI	
		without contact protection	
		Housing Colour black	1591 0200 0200
		Housing Colour red	1591 0200 0220
		contact protected	
Housing Colour black	1591 0200 0210		
Housing Colour red	1591 0200 0230		
EVoline Express Type 910 3 gang Power Bar, VDE for plug types: F, E+F, C rated voltage: 250 V / 50 Hz rated current: 16 A halogen-free Dimensions : 46 × 59 × 198 mm		Wieland GST 18	
		without contact protection	
		Housing Colour black	1591 0300 0100
		Housing Colour red	1591 0300 0120
		contact protected	
		Housing Colour black	1591 0300 0110
		Housing Colour red	1591 0300 0130
		WAGO WINSTA MIDI	
		without contact protection	
		Housing Colour black	1591 0300 0200
		Housing Colour red	1591 0300 0220
		contact protected	
Housing Colour black	1591 0300 0210		
Housing Colour red	1591 0300 0230		

Description	Picture	Specifications	Order Number
<p>EVoline Express Type 910 4-fach Power Bar, VDE</p>		<p>Wieland GST 18</p>	
<p>for plug types: F, E+F, C rated voltage: 250 V / 50 Hz. rated current: 16 A halogen-free</p>		<p>without contact protection</p>	
<p>Dimensions : 46 × 59 × 248 mm</p>		<p>Housing Colour black</p>	<p>1591 0400 0100</p>
		<p>Housing Colour red</p>	<p>1591 0400 0120</p>
		<p>contact protected</p>	
		<p>Housing Colour black</p>	<p>1591 0400 0110</p>
		<p>Housing Colour red</p>	<p>1591 0400 0130</p>
		<p>WAGO WINSTA MIDI</p>	
		<p>without contact protection</p>	
		<p>Housing Colour black</p>	<p>1591 0400 0200</p>
	<p>Housing Colour red</p>	<p>1591 0400 0220</p>	
	<p>contact protected</p>		
	<p>Housing Colour black</p>	<p>1591 0400 0210</p>	
	<p>Housing Colour red</p>	<p>1591 0400 0230</p>	









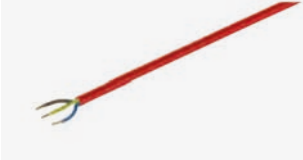

Description	Picture	Specifications	Order Number
<p>EVoline Express Type 910 2 gang Power Bar, BE/FR</p> <p>for plug types: F, E+F, C rated voltage: 250 V / 50 Hz rated current: 16 A halogen-free</p> <p>Dimensions : 46 × 59 × 148 mm</p>		<p>Wieland GST 18</p> <p>without contact protection</p> <p>Housing Colour black</p> <p>Housing Colour red</p> <p>WAGO WINSTA MIDI</p> <p>without contact protection</p> <p>Housing Colour black</p> <p>Housing Colour red</p>	<p>1591 0201 0100</p> <p>1591 0201 0120</p> <p>1591 0201 0200</p> <p>1591 0201 0220</p>
<p>EVoline Express Type 910 3 gang Power Bar, BE/FR</p> <p>Rated voltage: 250V / 50 Hz Rated current: 16 A halogen-free</p> <p>Dimensions : 46 × 59 × 198 mm</p>		<p>Wieland GST 18</p> <p>without contact protection</p> <p>Housing Colour black</p> <p>Housing Colour red</p> <p>WAGO WINSTA MIDI</p> <p>without contact protection</p> <p>Housing Colour black</p> <p>Housing Colour red</p>	<p>1591 0301 0100</p> <p>1591 0301 0120</p> <p>1591 0301 0200</p> <p>1591 0301 0220</p>
<p>EVoline Express Type 910 4-fach Power Bar, BE/FR</p> <p>Rated voltage: 250V / 50 Hz Rated current: 16 A halogen-free</p> <p>Dimensions : 46 × 59 × 248 mm</p>		<p>Wieland GST 18</p> <p>without contact protection</p> <p>Housing Colour black</p> <p>Housing Colour red</p> <p>WAGO WINSTA MIDI</p> <p>without contact protection</p> <p>Housing Colour black</p> <p>Housing Colour red</p>	<p>1591 0401 0100</p> <p>1591 0401 0120</p> <p>1591 0401 0200</p> <p>1591 0401 0220</p>

Description	Picture	Specifications	Order Number
<p>EVoline Express Type 910 2 gang Power Bar, CH</p> <p>Rated voltage: 250V / 50 Hz Rated current: 10 A halogen-free</p> <p>Dimensions : 46 × 59 × 148 mm</p>		<p>Wieland GST 18</p> <p>without contact protection Housing Colour black Housing Colour red</p> <p>WAGO WINSTA MIDI</p> <p>without contact protection Housing Colour black Housing Colour red</p>	<p>1591 0203 0100 1591 0203 0120 1591 0203 0200 1591 0203 0220</p>
<p>EVoline Express Type 910 3 gang Power Bar, CH</p> <p>Rated voltage: 250V / 50 Hz Rated current: 10 A halogen-free</p> <p>Dimensions : 46 × 59 × 198 mm</p>		<p>Wieland GST 18</p> <p>without contact protection Housing Colour black Housing Colour red</p> <p>WAGO WINSTA MIDI</p> <p>without contact protection Housing Colour black Housing Colour red</p>	<p>1591 0303 0100 1591 0303 0120 1591 0303 0200 1591 0303 0220</p>
<p>EVoline Express Type 910 4 gang Power Bar, CH</p> <p>Rated voltage: 250V / 50 Hz Rated current: 10 A halogen-free</p> <p>Dimensions : 46 × 59 × 248 mm</p>		<p>Wieland GST 18</p> <p>without contact protection Housing Colour black Housing Colour red</p> <p>WAGO WINSTA MIDI</p> <p>without contact protection Housing Colour black Housing Colour red</p>	<p>1591 0403 0100 1591 0403 0120 1591 0403 0200 1591 0403 0220</p>



Description	Picture	Specifications	Order Number
<p>EVoline Express Typ 910 2 gang Power Bar, GB</p> <p>Rated voltage: 250 V / 50 Hz halogen-free</p> <p>Dimensions: 46 × 59 × 148 mm</p>		<p>Wieland GST 18</p> <p>with contact protection Housing Colour black Rated current: 13 A</p> <p>with contact protection Housing Colour black Single fuse: 3,15 A</p> <p>with contact protection Housing Colour black Single fuse: 5 A</p>	<p>1591 0206 0110</p> <p>1591 0207 0110</p> <p>1591 0208 0110</p>
<p>EVoline Express Typ 910 3 gang Power Bar, GB</p> <p>Rated voltage: 250 V / 50 Hz halogen-free</p> <p>Dimensions: 46 × 59 × 198 mm</p>		<p>Wieland GST 18</p> <p>with contact protection Housing Colour black Rated current: 13 A</p> <p>with contact protection Housing Colour black Single fuse: 3,15 A</p> <p>with contact protection Housing Colour black Single fuse: 5 A</p>	<p>1591 0306 0110</p> <p>1591 0307 0110</p> <p>1591 0308 0110</p>
<p>EVoline Express Typ 910 4 gang Power Bar, GB</p> <p>Rated voltage: 250 V / 50 Hz halogen-free</p> <p>Dimensions: 46 × 59 × 248 mm</p>		<p>Wieland GST 18</p> <p>with contact protection Housing Colour black Rated current: 13 A</p> <p>with contact protection Housing Colour black Single fuse: 3,15 A</p> <p>with contact protection Housing Colour black Single fuse: 5 A</p>	<p>1591 0406 0110</p> <p>1591 0407 0110</p> <p>1591 0408 0110</p>
<p>EVoline Express Type 901 3 gang Power Bar</p> <p>Rated voltage: 250V / 50 Hz Rated current: 16 A halogen-free</p> <p>Dimensions : 39 x 59 x 186 mm</p>		<p>Wieland GST 18</p> <p>Housing Colour black Housing Colour red</p>	<p>1590 1100 1500 1590 1100 1600</p>





Description	Picture	Specifications	Order Number
<p>EVoline Express Interference Filter</p>		<p>Wieland GST 18</p>	<p>1592 0112 7500</p>
<p>2-pin with plug and socket</p>		<p>Housing Colour black Housing Colour red</p>	<p>1592 0112 7600</p>
<p>Dimensions : 39 × 59 × 188 mm</p>		<p>WAGO WINSTA MIDI</p>	<p>1592 0112 7700</p>
<p>25 A, sensivity 30 mA with plug and socket</p>		<p>Housing Colour black Housing Colour red</p>	<p>1592 0112 7800</p>
<p>Dimensions : 90 × 59 × 159 mm</p>		<p>Wieland GST 18</p>	<p>1592 2110 4500</p>
<p>16 A, Characteristic B 2-pole with plug and socket</p>		<p>Housing Colour black Housing Colour red</p>	<p>1592 2110 4600</p>
<p>Dimensions : 90 × 59 × 159 mm</p>		<p>WAGO WINSTA MIDI</p>	<p>1592 2110 4700</p>
<p>16 A, Characteristic B 2-pole with plug and socket</p>		<p>Housing Colour black Housing Colour red</p>	<p>1592 2110 4800</p>
<p>EVoline Express MCB Circuit protection switch</p>		<p>Wieland GST 18</p>	<p>1592 2110 3500</p>
<p>10 A, Characteristic B 2-pole with plug and socket</p>		<p>Housing Colour black Housing Colour red</p>	<p>1592 2110 3600</p>
<p>Dimensions : 90 × 59 × 159 mm</p>		<p>WAGO WINSTA MIDI</p>	<p>1592 2110 3700</p>
<p>16 A, Characteristic B 2-pole with plug and socket</p>		<p>Housing Colour black Housing Colour red</p>	<p>1592 2110 3800</p>
<p>EVoline Express MCB Circuit protection switch</p>		<p>Wieland GST 18</p>	<p>1592 2110 2500</p>
<p>10 A, Characteristic B 2-pole with plug and socket</p>		<p>Housing Colour black Housing Colour red</p>	<p>1592 2110 2600</p>
<p>Dimensions : 90 × 59 × 159 mm</p>		<p>WAGO WINSTA MIDI</p>	<p>1592 2110 2700</p>
<p>16 A, Characteristic B 2-pole with plug and socket</p>		<p>Housing Colour black Housing Colour red</p>	<p>1592 2110 2800</p>
<p>EVoline Express RCD Residual current device switch / MCB Circuit protection switch</p>		<p>Wieland GST 18</p>	<p>1599 0910 9700</p>
<p>16 A, 30 mA Type A Characteristic B 2-pole with plug and socket</p>		<p>Housing Colour black</p>	<p>1599 0910 9700</p>
<p>Dimensions : 90 × 59 × 159 mm</p>			

Description	Picture	Specifications	Order Number
<p>EVoline Express Power Cord</p> <p>Germany, Austria, France with Angled plug and socket connector Colour: black</p>		<p>GST 18 (Connector)</p> <p>Cable length 3 m Cable length 4 m Cable length 5 m</p> <p>WAGO WINSTA (Connector)</p> <p>Cable length 3 m Cable length 4 m Cable length 5 m</p>	<p>6590 0603 0500 6590 0604 0500 6590 0605 0500 6590 0903 0100 6590 0904 0100 6590 0905 0100</p>
<p>EVoline Express Power Cord</p> <p>Germany, Austria, France with Angled plug and socket connector Colour: red</p>		<p>GST 18 (Connector)</p> <p>Cable length 3 m</p> <p>WAGO WINSTA (Connector)</p> <p>Cable length 3 m Special lengths from 100 pieces on request</p>	<p>1590 0603 0600 1590 0903 0200</p>
<p>EVoline Express Power Cord</p> <p>Great Britain, 13 A with Angled plug and socket connector Colour: black</p>		<p>GST 18 (Connector)</p> <p>Cable length 3 m</p>	<p>6591 1603 0500</p>
<p>EVoline Express Power Cord</p> <p>Switzerland with safety plug and socket connector</p>		<p>GST 18 (Connector)</p> <p>Cable length 3 m, 10A Cable length 3 m, 16A</p> <p>WAGO WINSTA (Connector)</p> <p>Cable length 3 m, 10A</p>	<p>1590 0623 0500 1590 0663 0500 1590 0923 0100</p>
<p>EVoline Express Power Supply Module with Overload Circuit Breaker</p> <p>Plug type J (T12) Power Supply Module with resettable overload switch 10 A 3× 1,5 mm² i.e. Switzerland</p>		<p>GST 18 (Connector)</p> <p>Cable length 3 m</p>	<p>9332 0911 7200</p>

Description	Picture	Specifications	Order Number
<p>EVoline Express Connecting cable</p> <p>Freely configurable cable, Plug and socket.</p>		<p>Cable: Cable 3 x 1,5 mm², black Length 1m (Minimum 0,2 meter) Cable extension per meter (purchase from 0.1 m)</p>	9331 7920 0000
		<p>Cable 3 x 1,5 mm², red Length 1m (Minimum 0,2 meter) Cable extension per meter (purchase from 0.1 m)</p>	9331 7930 0000
		<p>Plug: Plug GST 18</p>	9331 7940 0000
		<p>Plug WAGO WINSTA MIDI</p>	9331 7950 0000
		<p>Plug Neutrik powerCON</p>	9332 4260 0000
		<p>Connector: Connector GST 18</p>	9331 7960 0000
		<p>Connector WAGO WINSTA MIDI</p>	9331 7970 0000
		<p>Connector Neutrik powerCON</p>	9332 4270 0000
<p>EVoline Express Socket Connector</p> <p>Severally, without cable.</p>		<p>Plug: Plug GST 18</p>	1599 0907 7000
		<p>Plug WAGO WINSTA MIDI</p>	1599 0910 9500
		<p>Connector: Connector GST 18</p>	1599 0905 9000
		<p>Connector WAGO WINSTA MIDI</p>	1599 0910 9600

Description	Picture	Specifications	Order Number
<p>Distributor Wieland GST18</p> <p>250 V, 20 A Input: Plug 3-pole</p>		<p>2x Output: Connector 3-pole Flat Shape with Lock without Mounting clip</p>	6599 0906 8300
		<p>2x Output: Connector 3-pole T-Shape with Lock without Mounting clip</p>	6599 0905 2200
		<p>2x Output: Connector 3-pole h-Shape with Lock without Mounting clip</p>	6599 0911 3000
		<p>3x Output: Connector 3-pole with Lock with Mounting plate</p>	1599 0911 7000
		<p>5x Output: Connector 3-pole with Lock with Mounting plate</p>	1599 0911 7100
<p>Y-Cable Distributor Wieland GST18</p> <p>1x Input, Plug 3-pole, GST18</p>		<p>2x Output, Connector 3-pole, GST18 with Lock without Mounting clip Lenght: 300 mm</p>	6599 0906 6600

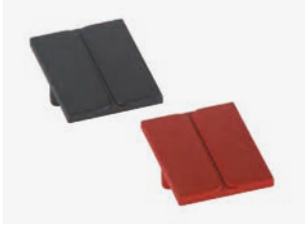



Description	Picture	Specifications	Order Number
<p>Distributor WAGO WINSTA</p> <p>250 V, 25 A Input: Plug 3-pole</p>		<p>2x Output: Connector 3-pole T-Shape with Lock without Mounting clip</p>	<p>6599 0906 9100</p>
		<p>2x Output: Connector 3-pole h-Shape with Lock with Mounting plate</p>	<p>1599 0911 7600</p>
		<p>3x Output: Connector 3-pole with Lock with Mounting plate</p>	<p>1599 0911 7300</p>
		<p>5x Output: Connector 3-pole with Lock with Mounting plate</p>	<p>1599 0911 7400</p>





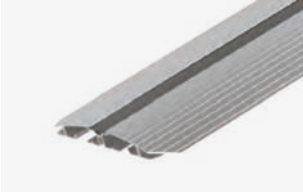
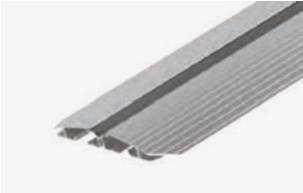

Description	Picture	Specifications	Order Number
<p>EVoline Rail</p> <p>For under desk installation, for the EVoline Express range. Black plastic brackets. Black aluminium profiles</p>		<p>2 black plastic brackets with 2 aluminium profiles</p> <p>Profile length 165 mm (for 3 gang)</p> <p>Profile length 215 mm (for 4 gang)</p>	<p>1593 5400 0300</p> <p>1593 5400 0400</p>
		<p>Individual</p> <p>1 black plastic brackets for EVoline Express</p>	<p>9331 6230 0000</p>
		<p>1 pair of Aluminium profiles per 100 mm</p>	<p>9331 6210 0000</p>
<p>EVoline Express Module Connector</p> <p>for a safe connection of plugged EVoline modules (for Express 901/910)</p>		<p>black</p> <p>red</p>	<p>1591 1830 0100</p> <p>1591 1830 0200</p>
<p>EVoline Express GST18 latches</p> <p>Free cable connections snap-on for jacks or suitable plugs. According to approvals a locking must be provided.</p>		<p>black</p>	<p>1599 0909 6700</p>





EVOLine[®] Cable Management





Description	Picture	Order Number
<p>Bridge Module Arc 90°</p> <p>includes 4 Fixing bolts</p>		1593 5090 0600
<p>Bridge Module T</p> <p>includes 6 Fixing bolts</p>		1593 5090 0500
<p>Bridge Module Cross</p> <p>includes 8 Fixing bolts</p>		1593 5090 0200
<p>Bridge Module Adaptor WireLane</p> <p>can also be used as end piece.</p>		1593 5090 0100
<p>Bridge Module Vertical</p>		1593 5090 0400
<p>Bridge Connectors</p> <p>2 Pieces</p>		1593 5090 0300

Description	Picture	Specifications	Order Number
<p>EVoline Bridge</p> <p>cable cover made of aluminium for screw fixing, with black trim, without screws</p>		<p>4 CableClips</p> <p>Length: 500 mm Length: 800 mm Length: 1.200 mm</p>	<p>1593 5010 5000 1593 5010 8000 1593 5011 2000</p>
		<p>8 CableClips</p> <p>Length: 1.600 mm Length: 2.000 mm</p>	<p>1593 5011 6000 1593 5012 0000</p>
<p>EVoline Bridge</p> <p>cable cover made of aluminium With double-sided tape with black trim</p>		<p>4 CableClips</p> <p>Length: 500 mm Length: 800 mm Length: 1.200 mm</p>	<p>1593 5020 5000 1593 5020 8000 1593 5021 2000</p>
		<p>8 CableClips</p> <p>Length: 1.600 mm Length: 2.000 mm</p>	<p>1593 5021 6000 1593 5022 0000</p>
<p>EVoline WireLane</p> <p>under desk cable channel made of plastic. The elements can be linked and separated.</p> <p>Width: 80 mm</p>		<p>Length: 750 – – 1000 mm</p> <p>Colour: black Colour: lightgrey</p>	<p>6593 5201 0000 6593 5211 0000</p>
<p>EVoline WireLane Strain Relief</p> <p>in black plastic with two clamps for cable</p>			<p>6593 5290 0100</p>
<p>EVoline CableFlex</p> <p>Plastic tube for cables. Black</p>		<p>Ø 15 mm, Length 50 m Ø 20 mm, Length: 30 m Ø 25 mm, Length: 20 m</p>	<p>6593 5300 0100 6593 5310 0100 6593 5320 0100</p>
<p>EVoline CableFlex</p> <p>Insertion tool</p>		<p>Ø 15 mm Ø 20 mm Ø 25 mm</p>	<p>6593 5390 0100 6593 5390 0200 6593 5390 0300</p>





Description	Picture	Specifications	Order Number
<p>EVOLine Rail</p> <p>For under desk installation, For EVOLine U-Dock and EVOLine Express. Bespoke profile lengths available upon request.</p>		<p>for EVOLine U-Dock</p> <p>2 black plastic brackets with 2 aluminium profiles</p> <p>Profile length 150 mm 1593 5400 0700 Profile length 300 mm 1593 5400 0100 Profile length 500 mm 1593 5400 0200</p>	
		<p>3 black plastic brackets with 4 aluminium profiles</p> <p>Profile length 2 x 300 mm 1593 5400 0500 Profile length 2 x 400 mm 1593 5400 0600</p>	
		<p>For EVOLine Express</p> <p>2 black plastic brackets with 2 aluminium profiles</p> <p>Profile length 165 mm 1593 5400 0300 (for 3-gang)</p> <p>Profile length 215 mm 1593 5400 0400 (for 4-gang)</p>	
		<p>Individual</p> <p>1 black plastic brackets for EVOLine Express 9331 6230 0000</p>	
		<p>1 black plastic brackets for EVOLine U-Dock 9331 6220 0000</p>	
		<p>1 Pair Aluminium profiles per 100 mm 9331 6210 0000</p>	







Description	Picture	Specifications	Order Number	
<p>Cable Passage EVOLine Port</p> <p>Aluminium housing, silver anodised Without modules</p> <p>Mounting hole \varnothing 102 mm</p>		<p>Rocking cover and collar made of silver lacquered plastic</p>	1593 1002 5301	
		<p>Rocking cover and collar made of black lacquered plastic</p>	1593 1003 2601	
		<p>Rocking cover made of solid stainless steel in CD-look, collar made of plastic, painted to match</p>	1593 1003 2701	
<p>Cable Outlet-Modul</p> <p>1 cable passage</p> <p>installation dimensions: 50 x 50 mm</p>		<p>\varnothing 8 mm \varnothing 12 mm \varnothing 17 mm Other \varnothing on request</p>	<p>9331 3790 0000 9331 0560 0000 9331 1670 0000</p>	
<p>Cable Outlet-Modul</p> <p>2 cable passages</p> <p>Installation dimensions: 50 x 50 mm</p>			<p>\varnothing 8 mm \varnothing 12 mm Other \varnothing on request</p>	<p>9331 3800 0000 9331 1930 0000</p>
<p>Cable Guide-Modul</p> <p>for EVOLine Port</p> <p>Clamp for 3 cables</p> <p>2x 8 mm</p> <p>1x 12 mm</p> <p>Colour: black</p> <p>Installation dimensions: 25 x 50 mm</p>				







Description	Picture	Specifications	Order Number
<p>Empty Floor Outlet</p> <p>cable passage for installation in double and cavity floors, cover with bracket for EVOLine WireLane.</p> <p>Installation dimensions: Ø 125 mm</p>		<p>black lightgrey</p>	<p>1594 9000 0000 1594 9100 0000</p>
<p>Floor Outlet with electrical socket insert</p> <p>VDE-compliant, black, with contact protection, with 3.0 m cable and plug GST18, cover with bracket for EVOLine WireLane</p> <p>Installation dimensions: Ø 125 mm</p>		<p>Cover black Cover lightgrey</p>	<p>1594 9000 0100 1594 9100 0100</p>

EV0line® Accessories



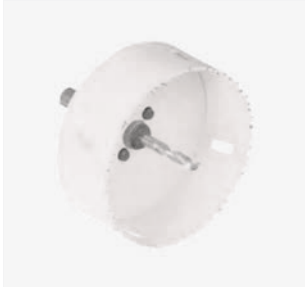

Description	Picture	Specifications	Order Number
<p>Mounting Clamp</p> <p>twist-proof including non-slip covering Colour: black for profiles: Dock, U-Dock, R-Dock</p>		<p>Span width 8 – 40 mm</p> <p>Span width 8 – 40 mm, 2×</p> <p>Span width 40 – 75 mm</p> <p>Span width 40 – 75 mm, 2×</p>	<p>1599 0902 1200</p> <p>1599 0902 0500</p> <p>1599 0902 1300</p> <p>1599 0902 1000</p>
<p>Mounting Clamp</p> <p>twist-proof including non-slip covering Colour: white for profiles: Dock, U-Dock, R-Dock</p>		<p>Span width 8 – 40 mm</p> <p>Span width 8 – 40 mm, 2×</p> <p>Span width 40 – 75 mm</p> <p>Span width 40 – 75 mm, 2×</p>	<p>1599 0909 3300</p> <p>1599 0909 5600</p> <p>1599 0909 3900</p> <p>1599 0909 5700</p>
<p>Stainless Steel Mounting Clamp</p> <p>twist-proof desk clamp installed and secured with allen screws. For profiles: Dock, U-Dock, R-Dock, V-Dock</p>		<p>Span width 18 – 25 mm</p>	<p>1599 0909 1500</p>
<p>Mounting set for under cabinet installation</p> <p>consists of two EVOLine Dock brackets with wood screws screw: 3.5 x 15 mm</p>			<p>1599 0903 8300</p>
<p>Mounting set for desk installation</p> <p>consists of two EVOLine Dock brackets with wing nut screws screw: M4 x 40 mm</p>			<p>1599 0903 8200</p>

Description	Picture	Specifications	Order Number
<p>Stainless Steel Pillar</p> <p>Steel pillar for EVOLine Docks consisting of: stainless steel sleeve, screw, nut, washer and rubber seal for profiles: Dock, R-Dock, U-Dock</p>		<p>Material : Stainless steel for surface thickness up to 50 mm</p>	<p>1599 0906 0700</p>
<p>Angle Profile</p> <p>for fixing of EVOLine V-Dock</p>		<p>Length: 100 mm Length: 60 mm</p>	<p>1599 0908 4400 1599 0909 6400</p>
<p>EVOLine Quicklock Pro</p> <p>fixing system with a concealed cable channel and 2 fasteners, for surface thickness of 18 to 32 mm, installation without tools, fasteners with protective underlay for profiles: EVOLine Dock, EVOLine R-Dock</p>		<p>Length: 100 mm without bracket</p> <p>length: 150 mm includes bracket for Wire-Lane connection</p> <p>length: 200 mm includes bracket for EVOLine WireLane connection</p>	<p>1599 0910 8500 1599 0910 8300 1599 0910 8400</p>
<p>Mounted on product</p>		<p>profile min. length: 100 mm price unit: 100 mm</p>	<p>9331 6700 0000</p>
<p>Fastening element</p>		<p>Fastening element</p>	<p>9332 0300 0000</p>
<p>WireLane bracket</p>		<p>WireLane bracket usable from 150 mm profile length</p>	<p>9331 6720 0000</p>

Description	Picture	Specifications	Order Number
<p>Double Sided Strip for EVOLine Dock Square</p> <p>2× Double Sided Strips Removable without residue.</p>			9332 1050 0000
<p>EVOLine Rubber gasket</p> <p>fits under the collar of the EVOLine Port.</p>			1599 0903 9100
<p>EVOLine Laptop Secure</p> <p>Sturdy mounting lug for commercial laptop anti-theft devices. Such as Kensington Lock.</p>		<p>Die-cast, silver-colored Length: 41 mm Breite: 9 mm Höhe: 22 mm</p>	9331 3140 0000
<p>EVOLine Laptop Secure</p> <p>Sturdy attachment loop for standard laptop theft protection Such as Kensington Lock.</p>		Silver-colored	9331 6030 0000
<p>EVOLine Hole Saw</p> <p>For precise installation.</p>		<p>Mounting hole Ø 102 mm (for Evoline Port)</p> <p>Mounting hole Ø 83 mm (for Evoline Square80)</p> <p>Mounting hole Ø 54 mm (for Evoline One)</p>	1599 0901 7000
<p>EVOLine Unlocking Tool for interchangeable modules</p>			6599 0911 1300

EVOLine® Sales support



Description	Picture	Specifications	Order Number
<p>EVOLine sample display</p> <p>Fully functional, equipped with EVOLine BackFlip, Circle80, FlipTop Push S, FrameDock, Qi Charger, One, Square80.</p> <p>With carrier bag made of robust tarpaulin incl. shoulder strap.</p> <p>Without connecting cable.</p>		<p>VDE</p> <p>International</p> <p>Bag separate, without display.</p> <p>Felt insert for bag, for carrying smaller displays or products.</p>	<p>WM65 9909 1157</p> <p>WM65 9909 1161</p> <p>WM65 9909 1169</p> <p>WM65 9909 1181</p>
<p>EVOLine sample display One</p> <p>Sample display for installation demonstration.</p> <p>With 3 EVOLine One sockets: surface-mounted, flush-mounted, with cover.</p>		<p>VDE</p> <p>UK</p> <p>B/F</p> <p>CH 10A</p>	<p>WM65 9909 1163</p> <p>WM65 9909 1164</p> <p>WM65 9909 1165</p> <p>WM65 9909 1166</p>
<p>EVOLine sample display One Upholstery installation</p> <p>Sample display for installation demonstration of the EVOLine One in an upholstered piece of furniture.</p>		<p>Flat upholstery</p> <p>High upholstery</p>	<p>WM65 9909 1179</p> <p>WM65 9909 1180</p>

EVOLine®

Schulte Elektrotechnik GmbH & Co. KG

Juengerstrasse 21
D-58515 Luedenscheid
Germany

Telephone +49 23 51 / 94 81-0
Fax +49 23 51 / 4 26 58

E-Mail info@schulte.com
Internet www.evoline.com

