

Viewmate monitor arm - desk 662

At Dataflex, we care about the environment. That is why we created this ecosheet. In it we give an accurate overview of the environmental footprint of this product and how we can reduce it together through recycling.



Global Warming Potential (GWP)

The environmental footprint of this Dataflex product is calculated in terms of Global Warming Potential (GWP), which is the impact the product has on climate change in kg CO₂ equivalent.



Kilometers by car

To further clarify the GWP in a way that everyone can understand, we created the 'average car equivalent'.**

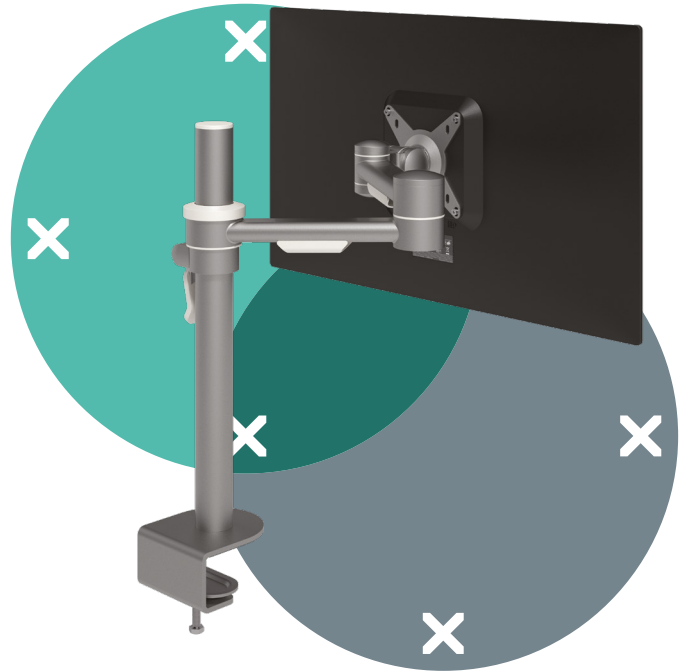

Environmental footprint



Without recycling agreement



17.90 kg CO₂



56.24 km



With recycling agreement



14.72 kg CO₂



46.25 km



You can contribute!

If you would like to have a positive impact on the environment and reduce your carbon footprint, please contact us for information on our recycling agreement options. recycle@dataflex-int.com

Environmental footprint in detail

Product

In this table we show you the composition of the product and the GWP per type of material.

	Steel	Aluminium	Plastic	Wood / rubber	Paint / coating / glue	Product
Weight (g)	3702.00	18.00	123.00	0.00	32.00	3875.00
% of total weight	95.54	0.46	3.17	0.00	0.83	100.00
GWP (kg CO ₂ eq.)	15.47	0.17	0.72	0.00	0.26	16.62

Transport and Dataflex

After production the product has to be shipped to our warehouse and sold. This table shows the GWP added by shipping and Dataflex processes.

	Product	Transport	Dataflex processes	Total Without recycling
GWP (kg CO ₂ eq.)	16.62	1.02	0.25	17.90

Recycling

With recycling, we can drastically reduce the environmental footprint of a product.

	Total Without recycling	Recycling	Total With recycling
GWP (kg CO ₂ eq.)	17.90	-3.18	14.72

Contact

For any questions or remarks, please feel free to contact our Quality, Health & Safety and Environment department at

QHSE@dataflex-int.com

www.dataflex-int.com

The calculations to create this ecosheet were performed in cooperation with Ecochain BV

www.ecochain.com

This Ecosheet is a first step in LCA information that Dataflex discloses. Full Environmental Product Declarations (EPD's) will become available at a later stage.

* Validity: Up to 1 year after issue date in upper right hand corner.

** 1 kg CO₂ eq. is equal to 3.14 km with the average car (source: Ecoinvent 3.2).